



3/8"



ESAGONO

BGS articolo	DESCRIZIONE	Euro
BGS 5109	SET 6 PEZZI, CHIAVI A BUSSOLA ESAGONO MASCHIO CON TESTA SFERICA, ATTACCO 3/8", 3-8 MM	18,62

CARATTERISTICHE

- con testa sferica
- 3 - 4 - 5 - 5.5 - 6 - 8 mm, lunghezza 50 mm
- in acciaio al cromo vanadio
- satinate
- zigrinate
- su guida



1/4"-3/8"-1/2"

ESAGONO



BGS articolo	DESCRIZIONE	Euro
BGS 5099	SET 10 PEZZI, CHIAVI A BUSSOLA ESAGONALI EXTRA CORTE, 4 - 19 MM	30,60

CARATTERISTICHE

- attacco 1/4", lunghezza 30 mm: 4 - 5 - 6 - 7 - 8 mm
- attacco 3/8", lunghezza 38 mm: 10 - 12 - 14 mm
- attacco 1/2", lunghezza 48 mm: 17 - 19 mm
- zigrinate
- finitura cromata satinata
- su guida metallica



3/8"



BGS articolo	DESCRIZIONE	Euro
BGS 9341	SET 7 PEZZI, CHIAVI A BUSSOLA TORX CON FORO MASCHIO, TH15-TH50, ATT. 3/8"	19,13

CARATTERISTICHE

- misure: TH15-TH20-TH25-TH30-TH40-TH45-TH50
- lunghezza: 48 mm
- zigrinate
- finitura satinata cromata
- su guida metallica



3/8"



ESAGONO

BGS articolo	DESCRIZIONE	Euro
BGS 5107	SET 7 PEZZI, CHIAVI A BUSSOLA ESAGONO MASCHIO, ATTACCO 3/8"	17,21

CARATTERISTICHE

- misure: 3-4-5-6-7-8-10 mm
- su guida metallica



3/8"



BGS articolo	DESCRIZIONE	Euro
BGS 5108	SET 7 PEZZI, BUSSOLE ATT. 3/8", TORX	17,72

CARATTERISTICHE

- Tx: 15- 20-25-30-40-45-50
- finitura cromata satinata
- su guida metallica



1/4"-3/8"-1/2"



BGS articolo	DESCRIZIONE	Euro
BGS 5105	SET 8 PEZZI, BUSSOLE XZN	21,17

CARATTERISTICHE

- comprende:
 - attacco 1/4": M4-M5-M6
 - attacco 3/8": M8-10-12
 - attacco 1/2": M-14-16
- finitura cromata satinata
- su guida metallica

POLLICI



3/8"

ESAGONO

BGS articolo	DESCRIZIONE	Euro
BGS 5104	SET 7 PEZZI, CHIAVI A BUSSOLA ESAGONO MASCHIO IN POLLICI, ATTACCO 3/8"	17,21

CARATTERISTICHE

- finitura cromata satinata
- misure in pollici: 1/8", 5/32", 3/16", 7/32", 1/4", 5/16", 3/8"
- ideali per auto e moto inglesi ed americane
- su guida metallica



1/4"-3/8"-1/2"





BGS articolo	DESCRIZIONE	Euro
BGS 5098	SET 12 PEZZI, CHIAVI A BUSSOLA TORX® EXTRA CORTE, T8 - T60	28,05

CARATTERISTICHE

- att. 1/4", lungh. 30 mm: T8-T10-T15-T20-T25-T27
- att. 3/8", lungh. 38 mm : T30-T40-T45-T50-T55
- attacco 1/2", lunghezza 48 mm: T60
- zigrinate
- finitura cromata satinata
- su guida metallica



3/8"

1/2"



BGS articolo	DESCRIZIONE	Euro
BGS 5185	SET 7 PEZZI, CHIAVI A BUSSOLA RIBE MASCHIO	33,02

CARATTERISTICHE

- attacco 3/8": M6, M7, M8, M10
- attacco 1/2": M12, M13, M14
- in acciaio al cromo vanadio
- satinare, zigrinate
- lunghezza: 75 mm
- su guida

NEW



Jeep **FIAT** **FCA**
FIAT CHRYSLER AUTOMOBILES

MORTORQ®

3/8"

articolo	DESCRIZIONE	Euro
TM-200601	SET 6 PEZZI, CHIAVI A BUSSOLA MORTORQ®, ATTACCO 3/8"	40,00

CARATTERISTICHE

- misure: MTS00 - MTS0 - MTS1 - MTS2 - MTS3 - MTS4
- lunghezza: 50 mm
- finitura cromata satinata
- in chrome vanadium
- su guida metallica
- per Jeep e FCA

3/8" 3/8"

PROLUNGHE
attacco: 3/8"

BGS articolo	L mm	box	Euro
BGS 296	50	1	3,95
BGS 294	75	1	4,83
BGS 295	150	1	6,93
BGS 3132	610	1	26,01

3/8" PRO 3/8"

BGS articolo

DESCRIZIONE	Euro
SET 3 PEZZI PROLUNGHE	17,85

CARATTERISTICHE

- lunghezze: 375-450-600 mm
- acciaio al carbonio
- lucide

3/8" 3/8"

PROLUNGHE TESTA SFERICA

BGS articolo	L mm	box	Euro
BGS 242	75	1	4,08
BGS 246	125	1	5,87
BGS 243	150	1	5,87
BGS 244	250	1	8,16
BGS 247	450	1	19,38

NEW

3/8" TESTA SFERICA

BGS articolo

DESCRIZIONE	Euro
SET 5 PEZZI, PROLUNGHE TESTA SFERICA, ATT. 3/8"	33,28

CARATTERISTICHE

- comprende le seguenti misure: - att. 3/8", lunghezza: 38, 75, 150, 250, 450 mm
- finitura cromata lucida
- in supporto in plastica

FERMEC 3-PC, square Head Set

• CR-V Steel with chrome plated
• Size: 1/4" & 3/8" & 1/2"



1/4" 3/8" 1/2"

articolo	DESCRIZIONE	Euro
483814	SET 3 PEZZI, ADATTATORI DOPPIO QUADRO	12,60

CARATTERISTICHE

- comprende i seguenti adattatori con doppia sfera:
 - 1/4" M - 1/4" F, lunghezza 20 mm, art. 2841
 - 3/8" M - 3/8" F, lunghezza 30 mm, art. 3841
 - 1/2" M - 1/2" F, lunghezza 37 mm, art. 4841

ADATTATORI DOPPIO QUADRO MASCHIO

articolo	L mm	Euro
2841	20	4,00
3841	30	5,00
4841	37	6,00
BGS 9623	53	9,69

CARATTERISTICHE

- con doppia sfera

NEW

1/4"-3/8"-1/2" TESTA SFERICA

BGS articolo

DESCRIZIONE	Euro
SET 9 PEZZI, PROLUNGHE TESTA SFERICA	40,04

CARATTERISTICHE

- comprende le seguenti misure:
 - att. 1/4", lunghezza: 50, 100, 225 mm;
 - att. 3/8", lunghezza: 75, 150, 225 mm;
 - att. 1/2", lunghezza: 50, 125, 250 mm.
- finitura cromata lucida
- in supporto in plastica

1/4"-3/8"-1/2" PRO+

BGS articolo

DESCRIZIONE	Euro
SET 9 PEZZI, PROLUNGHE TESTA SFERICA	55,97

CARATTERISTICHE

- comprende le seguenti misure:
 - att. 1/4", lunghezza: 50 mm, 100 mm, 250 mm;
 - att. 3/8", lunghezza: 75 mm, 150 mm, 250 mm;
 - att. 1/2", lunghezza: 50 mm, 125 mm, 250 mm.

RICAMBI

BGS articolo	L mm	Euro
BGS 2232	50	3,57
BGS 2231	100	3,83
BGS 2219	250	6,63
BGS 242	75	4,08
BGS 243	150	5,87
BGS 244	250	8,16
BGS 233	50	6,30
BGS 234	125	9,45
BGS 235	250	15,75

TESTA SFERICA

3/8" PRO+ CV 3/8"

BGS articolo	DESCRIZIONE	Euro
BGS 2239	SET 3 PEZZI, PROLUNGHE	20,27

CARATTERISTICHE

- lunghezze: 75-150-250 mm
- testa sferica
- finitura cromata satinata
- zigrinate

FLEX

FEMMINA MASCHIO

PROLUNGA FLESSIBILE MASCHIO - FEMMINA PER BUSSOLE

BGS articolo	MASCHIO	FEMMINA	L mm	Euro
3762	3/8"	3/8"	300	35,45

1/4"-3/8"-1/2" 1/4"-3/8"-1/2"

PRO+ CV

BGS articolo	DESCRIZIONE	Euro
BGS 198	SET 3 PEZZI, PROLUNGHE MAGNETICHE	17,72

CARATTERISTICHE

- per trattenerne viti e bulloni nella bussola

3/8" PRO+ CV

BGS articolo	DESCRIZIONE	Euro
BGS 288	ADATTATORE SCORREVOLE PER BARRE ATT. 3/8"	4,34

CARATTERISTICHE

- cromata, satinata
- per impiego con prolunghe

3/8" PRO+ 3/8"

BGS articolo	DESCRIZIONE	Euro
BGS 8617	PROLUNGA SPECIALE ATT. 3/8", 265 MM	95,63

CARATTERISTICHE

- particolarmente indicate per viti in posizione di difficile accesso
- consente la trasmissione eccentrica
- utile, ad esempio per le viti sulle coperture anteriori di motori trasversali e altre applicazioni
- permette uno spostamento di 265 mm
- coppia massima: 150 Nm
- dimensioni: 44 x 320 mm

3/8" 3/8"

SNODO

attacco: 3/8"

BGS articolo	L mm	Euro
BGS 299	55	6,80

1/4"-3/8"-1/2" 1/4"-3/8"-1/2"

PRO+ CV

BGS articolo	DESCRIZIONE	Euro
BGS 252	SET 3 PEZZI SNODO CON MOLLA	26,01

CARATTERISTICHE

- cromati

3/8" 3/8"

ASTA CON QUADRO MASCHIO 3/8" SCORREVOLE

attacco: 3/8"

BGS articolo	L mm	Euro
BGS 277	200	10,00

3/8"

IMPUGNATURE PORTA BUSSOLE

Kokon articolo	L mm	Euro
3769 N-160	160	15,32
3769 N-230	230	18,04

TESTA SFERICA

3/8"

IMPUGNATURE A TESTA SFERICA PORTA BUSSOLE

SISTEMA WOBBLE-FIX CON DUE MODALITÀ DI UTILIZZO:

- PROLUNGA TESTA SFERICA ANGOLO 15°
- PROLUNGA TRADIZIONALE

attacco: 3/8"

Kokon articolo	L mm	Euro
3769 NWF-160	160	17,30
3769 NWF-230	230	20,13

3/8" PRO+ CV

BGS articolo	DESCRIZIONE	Euro
BGS 7802	IMPUGNATURA A T, CON QUADRO MASCHIO DA 3/8" LUNGHEZZA 230 MM	12,24

CARATTERISTICHE

- impugnatura ergonomica
- finitura satinata



3/8" PRO+ CV

BGS articolo	DESCRIZIONE	Euro
BGS 7802-1	IMPUGNATURA A T, CON QUADRO MASCHIO DA 3/8", LUNGHEZZA 230 MM, TESTA SFERICA	14,54

CARATTERISTICHE

- impugnatura ergonomica
- finitura satinata

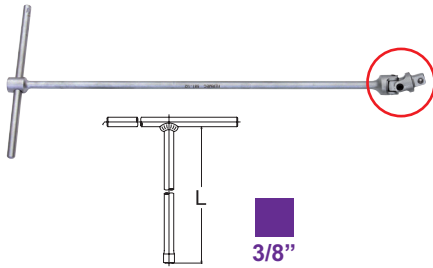

CHIAVE A "T" QUADRO MASCHIO SNODATA CROMATA ASTA SCORREVOLE CHROM-VANADIUM

BGS articolo	L mm	Euro
581-3/8"	500	18,90



CRICCHETTO REVERSIBILE CON QUADRO FEMMINA PASSANTE

BGS articolo	L mm	Euro
BGS 9160 NEW	115	23,14
3940	260	28,00
BGS 312	270	38,00
5840	450	60,00
BGS 9622 NEW	500	123,68
6040	250	30,00
6340	250	38,00
6540	250	38,00
6640	250	38,00

CARATTERISTICHE

- quadro passante
- impugnatura rivestita



NUOVO CRICCHETTO REVERSIBILI A 72 DENTI CON PULSANTE DI SBLOCCAGGIO DELLA BUSSOLA ED IMPUGNATURA ERGONOMICA BICOMPONENTE ANTISCIVOLO E FORMA OVALE

BGS articolo	L mm	Euro
672	190	31,50
576787	SET 3 PEZZI 1/4" - 3/8" - 1/2"	94,50



3/8" PRO+ CV

BGS articolo	DESCRIZIONE	Euro
BGS 2205	CHIAVE A CRICCHETTO REVERSIBILE 3/8"	27,92

CARATTERISTICHE

- impugnatura in ABS
- con pulsante di sgancio rapido
- lunghezza 210 mm



3/8" PRO+ CV

BGS articolo	DESCRIZIONE	Euro
BGS 2308	CRICCHETTO REVERSIBILE 3/8"	29,75

CARATTERISTICHE

- con pulsante di sgancio rapido
- impugnatura in gomma a in materiale bi-componente
- lunghezza 260 mm



3/8" PRO+ CV

BGS articolo	DESCRIZIONE	Euro
BGS 316	CRICCHETTO REVERSIBILE 3/8"	29,33

CARATTERISTICHE

- con pulsante di sgancio rapido
- impugnatura antiscivolo ergonomica in materiale bi-componente
- lunghezza 205 mm



3/8" CV

BGS articolo	DESCRIZIONE	Euro
BGS 518	CRICCHETTO REVERSIBILE, 72 DENTI, ATTACCO 3/8"	18,20

CARATTERISTICHE

- impugnatura in materiale bi-componente
- con sgancio rapido
- lunghezza 215 mm



3/8" PRO+ CV

BGS articolo	DESCRIZIONE	Euro
BGS 319	CRICCHETTO REVERSIBILE 3/8"	30,35

CARATTERISTICHE

- con pulsante di sgancio rapido
- stelo sfasato
- impugnatura antiscivolo ergonomica in materiale bi-componente
- lunghezza 205 mm

NEW **MECCANISMO 72 DENTI**



3/8" **PRO+**

BGS articolo	DESCRIZIONE	Euro
BGS 9090	CHIAVE A CRICCHETTO REVERSIBILE DA 3/8", 254 MM	38,00

CARATTERISTICHE

- 72 denti
- lunghezza: 254 mm
- impugnatura ergonomica antiscivolo in materiale bi-componente

NEW





3/8" **CV** **PRO+**

BGS articolo	DESCRIZIONE	Euro
BGS 601	CRICCHETTO REVERSIBILE, "EXTRA SLIM", ATTACCO 3/8"	38,00

CARATTERISTICHE

- cricchetto reversibile 72 denti
- modello dritto "extra slim"
- con pulsante di sgancio rapido
- acciaio al Cromo Vanadio
- lunghezza: 195 mm
- peso: 220 grammi
- impugnatura in materiale bi-componente

NEW





BGS 601-REPAIR



3/8" **CV** **PRO+**

BGS articolo	DESCRIZIONE	Euro
BGS 601	CRICCHETTO REVERSIBILE, MODELLO CURVO, ATTACCO 3/8"	21,68

CARATTERISTICHE

- cricchetto reversibile 90 denti
- modello curvo
- con pulsante di sgancio rapido
- acciaio al Cromo Vanadio
- lunghezza: 205 mm
- peso: 140 grammi
- impugnatura in materiale bi-componente

RICAMBI

BGS articolo	DESCRIZIONE	Euro
BGS 601-REPAIR	SET RIPARAZIONE CRICCHETTO	8,42

MECCANISMO 72 DENTI



3/8" **PRO+** **CV**

BGS articolo	DESCRIZIONE	Euro
BGS 209	CRICCHETTO "COMPATTO" 3/8"	27,80

CARATTERISTICHE

- extra-piccolo
- lunghezza 140 mm
- per spazi ristretti e angusti
- 72 denti
- con pulsante di sgancio rapido

CV



3/8" **CV**

BGS articolo	DESCRIZIONE	Euro
BGS 301	CRICCHETTO "KRAFTMANN" 3/8"	9,36

CARATTERISTICHE

- reversibile
- con impugnatura ergonomica in gomma
- lunghezza 200 mm

MECCANISMO 72 DENTI



3/8" **PRO+**

BGS articolo	DESCRIZIONE	Euro
BGS 303	CHIAVE A CRICCHETTO IN NYLON E FIBRA DI VETRO 3/8"	23,46

CARATTERISTICHE

- comodo utilizzo grazie ai materiali ultra-leggeri, nessun affaticamento
- i test su questo attrezzo hanno ottenuto risultati per capacità massima decisamente superiori ai limiti DIN
- lunghezza: circa 205 mm
- in polipropilene rivestito in acciaio CR-V con impugnatura in materiale bi-componente

QUANDO MANCA LO SPAZIO



3/8" **PRO+**

RUOTANDO L'IMPUGNATURA SI OTTIENE LA ROTAZIONE DEL QUADRO DX/SX

CRICCHETTO DOPPIA FUNZIONE:

- AZIONE A "CRICCO TRADIZIONALE"
- IMPUGNATURA ROTATIVA
- QUADRO MASCHIO SCORREVOLE

FERMEC articolo	L mm	1	Euro
952	3/8"	240	42,00



BGS 356-REPAIR

MECCANISMO 60 DENTI

3/8" PRO+ CV

BGS articolo	DESCRIZIONE	Euro
BGS 356	CHIAVE A CRICCHETTO ADATTA PER ESSERE USATA CON UNA SOLA MANO 3/8"	42,08

- CARATTERISTICHE**
- interruttore destro e sinistro si trovano nell'impugnatura della chiave, cosicché è possibile cambiare direzione usando la stessa mano che tiene la chiave
 - testa cricchetto extra-piatta
 - 60 denti
 - angolo di rotazione ridotto
 - finitura ad alta resistenza
 - lunghezza 200 mm

RICAMBI

BGS articolo	DESCRIZIONE	Euro
NEW BGS 356-REPAIR	KIT DI RIPARAZIONE	19,13

TESTA SNODATA

MECCANISMO 72 DENTI

3/8" PRO+ CV

BGS articolo	DESCRIZIONE	Euro
BGS 113	CHIAVE A CRICCHETTO CON TESTA SNODATA, REGOLABILE, 3/8"	45,77

- CARATTERISTICHE**
- testa snodata 180°
 - finitura cromata
 - cricchetto reversibile 72 denti
 - con pulsante di sgancio rapido
 - lunghezza 230 mm

TESTA SNODATA + ESTENSIBILE

MECCANISMO 72 DENTI

3/8" PRO+ CV

BGS articolo	DESCRIZIONE	Euro
BGS 25106	CRICCHETTO REVERSIBILE ESTENSIBILE SNODATO, 240-340 MM, ATTACCO 3/8"	47,18

- CARATTERISTICHE**
- regolabile in 4 posizioni da 240 a 340 mm
 - testa snodata regolabile in 10 posizioni
 - cricchetto 72 denti
 - con pulsante di sgancio rapido
 - acciaio al cromo vanadio, satinato

MECCANISMO 45 DENTI

3/8" PRO+ CV

BGS articolo	DESCRIZIONE	Euro
BGS 286	CHIAVE A CRICCHETTO CON TESTA SNODATA, REGOLABILE 3/8"	49,88

- CARATTERISTICHE**
- finitura satinata cromata
 - testa snodata regolabile in 5 posizioni
 - 45 denti
 - con pulsante di sgancio rapido
 - impugnatura con occhiello
 - lunghezza 270 mm

MECCANISMO 72 DENTI

1/4"-3/8"-1/2"

PRO+ CV

BGS articolo	DESCRIZIONE	Euro
BGS 215	SET 3 PEZZI, CRICCHETTI REVERSIBILI COMPATTI	95,63

CARATTERISTICHE

- formato extra-small per spazi ridotti e angusti
- 72 denti
- lunghezza cricchetti:
 - attacco 1/4": 110 mm
 - attacco 3/8": 140 mm
 - attacco 1/2": 170 mm





MECCANISMO
45
DENTI



3/8" ESAGONO

BGS articolo	DESCRIZIONE	Euro
BGS 15112	SET 7 PEZZI, BUSSOLE DA 3/8"	31,20

CARATTERISTICHE

- chiave a cricchetto, reversibile con pulsante di sgancio rapido
- bussole da 8 - 10 - 13 - 15 - 17 e 19 mm



SURFACE
DRIVE



3/8"

SURFACE
DRIVE

CV

PRO+

BGS articolo	DESCRIZIONE	Euro
BGS 2227	SET 26 PEZZI, BUSSOLE	96,77

CARATTERISTICHE

- durezza e coppia in conformità con le norme DIN
- bussole "surface drive"
- 18 bussole: 6-7-8-9-10-11-12-13-14-15-16-17-18-19-20-21-22-24 mm
- bussole zigrinate, finitura satinata cromata
- 3 barre di prolunga 45-75-150 mm c/esagono
- 2 bussole per candele 16+21 mm
- 1 snodo
- chiave a cricchetto reversibile con pulsante di sgancio rapido
- adattatore 3/8" M - 1/2" F

RICAMBI

BGS articolo	DESCRIZIONE	Euro
BGS 2227-LEER	CASSETTA VUOTA	17,72



SURFACE
DRIVE



3/8"

CV

PRO+

BGS articolo	DESCRIZIONE	Euro
BGS 2229	SET 61 PEZZI, DI BUSSOLE	154,88

CARATTERISTICHE

- durezza e coppia in conformità con DIN
- chiavi a bussola: TX15-20-25-27-30-40-45-50-55
- PH 1-3
- PZ 1-3
- Taglio 5,5 - 7-8 mm
- Esagono 3-7, 8, 10 mm
- 18 bussole "Surface drive", 6-24 mm
- 10 bussole lunghe "Surface drive" 8-19 mm
- 2 bussole per candele 21 e 16 mm
- 1 snodo da 3/8" con molla
- 1 barra scorrevole a T/barra su prolunga 250 mm
- 1 barra di prolunga c/testa sferica 75 mm
- 1 chiave a cricchetto reversibile a 72 denti
- 1 adattatore da attacco quadro 3/8" x 8 mm esagonale

RICAMBI

BGS articolo	DESCRIZIONE	Euro
BGS 2229-LEER	CASSETTA VUOTA	18,62



POLLICI



3/8"

CV

PRO+

BGS articolo	DESCRIZIONE	Euro
BGS 2215	SET 61 PEZZI, BUSSOLE IN POLLICI	156,25

CARATTERISTICHE

- durezza e coppia in conformità con DIN
- chiavi a bussola: TX15-20-25-27-30-40-45-50-55
- PH 1-3,
- PZ 1-3
- inserti Taglio 7/32"-15/16"
- inserti esagonali 1/8"-3/8"
- 18 bussole esagonali 1/4"-15/16"
- 10 bussole lunghe esagonali 5/16"-3/4"
- 2 bussole per candele 5/8" + 13/16"
- 1 snodo da 3/8" con molla
- 1 barra scorrevole a T/barra di prolunga 250 mm
- 1 barra di prolunga c/testa sferica 75 mm
- 1 chiave a cricchetto reversibile a 72 denti
- 1 adattatore da attacco quadro 3/8" x 8 mm esagonale





BGS articolo	DESCRIZIONE	Euro
BGS 2218	CASSETTA 61 PEZZI, UTENSILI ATTACCO 3/8"	156,75

CARATTERISTICHE

- comprende i seguenti utensili attacco quadro 3/8":
 - cricchetto reversibile, 72 denti
 - prolunga, 75 mm
 - chiave a T con quadro scorrevole
 - snodo
 - adattatore esagonale 8 mm
 - bussole per candele 16 e 21 mm
 - 18 bussole esagonali: 6-8-9-10-11-12-13-14-15-17-19-20-21-22-24 mm
 - 10 bussole esagonali lunghe: 8-9-10-11-12-13-14-15-17-19 mm
 - 25 bussole maschio:
 - taglio: 5.5 - 7 - 8 mm
 - PH: 1 - 2 - 3
 - PZ: 1 - 2 - 3
 - esagonali: 3-4-5-6-7-8-10 mm
 - Torx: Tx15 - Tx20 - Tx27 - Tx25 - Tx30 - Tx40 - Tx45 - Tx50 - Tx55



BGS articolo	DESCRIZIONE	Euro
BGS 2289	SET 92 PEZZI, BUSSOLE ESAGONALI ATTACCO 1/4" E 3/8"	224,88

CARATTERISTICHE

- comprende i seguenti utensili attacco 1/4":
 - cricchetto reversibile 72 denti
 - bussole esagonali: 4 - 4.5 - 5 - 6 - 7 - 8 - 9 - 10 - 11 - 13 mm
 - bussole esagonali lunghe: 6 - 8 - 10 - 11 - 13 mm
 - 1 adattatore portainseriti
 - 1 impugnatura 150 mm
 - 1 snodo
 - 1 prolunga
 - 1 leva con quadro scorrevole
- comprende i seguenti utensili attacco 3/8":
 - cricchetto reversibile 72 denti
 - bussole esagonali: 14 - 15 - 16 - 17 - 19 - 20 - 21 - 22 - 23 - 24 mm
 - bussole esagonali lunghe: 14 - 16 - 17 - 19 mm
 - 1 adattatore portainseriti
 - 1 snodo
 - 1 prolunga
 - 3 bussole per candele: 16 - 18 - 21 mm
 - 1 riduzione quadro 3/8" Femmina - quadro 1/4" Maschio
- 29 inserti (S2):
 - Taglio: 2 - 2.5 - 3 - 4 - 5 - 6 - 7 mm
 - PH: PH0, PH1, PH2, PH3
 - PZ: PZ0, PZ1, PZ2, PZ3
 - Esagonali: 1.5 - 2 - 2.5 - 3 - 4 - 5 - 7 mm
 - Torx: TX10 - TX15 - TX20 - TX25 - TX27 - TX30 - TX40
- 9 chiavi combinate: 6 - 8 - 10 - 11 - 13 - 14 - 16 - 17 - 19 mm
- 9 chiavi a L esagonali: 1.5 - 2 - 2.5 - 3 - 4 - 5 - 6 - 8 - 10 mm



Ideale per AUTO & MOTO inglesi e americane



BGS articolo	DESCRIZIONE	Euro
BGS 2299	SET 92 PEZZI, BUSSOLE IN POLLICI	249,88

CARATTERISTICHE

- con bussole esagonali
- 2 chiavi a cricchetto a 72 denti 1/4" + 3/8"
- bussole corte, attacco 1/4": 5/32", 3/16", 7/32", 1/4", 9/32", 5/16", 11/32", 3/8", 7/16", 1/2"
- bussole lunghe, attacco 1/4": 1/4", 5/16", 3/8", 7/16", 1/2"
- adattatore inserto 1/4"
- 1 impugnatura con quadro 1/4" (6.3)
- 1 snodo 1/4"
- 1 barra di prolunga con esagono esterno, 1/4"
- 1 impugnatura scorrevole a T con adattatore 1/4"
- bussole corte, attacco da 3/8": 1/2", 9/16", 19/32", 5/8", 11/16", 3/4", 25/32", 13/16", 7/8", 15/16", 1"
- bussole lunghe, attacco da 3/8": 9/16", 5/8", 11/16", 3/4"
- adattatore inserto da 3/8"
- 1 snodo da 3/8"
- 1 barra di prolunga da 3/8"
- 3 bussole per candele: 5/8", 3/4", 13/16"
- assortimento di 29 pz. con Taglio, PH, PZ, Esagono, Torx
- set chiavi combinate da 9 pz.: 1/4", 5/16", 3/8", 7/16", 1/2", 9/16", 5/8", 11/16", 3/4"
- chiavi a Esagono: 1/16", 5/64", 3/32", 1/8", 5/32", 3/16", 1/4", 5/16", 3/8"
- 1 adattatore 1/4" M - 3/8" F

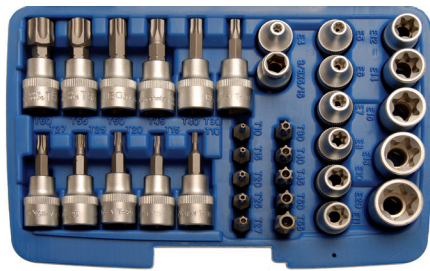

TORX®
TORX® CON FORO TORX®



3/8" ESAGONO 5/16" C

PRO+

CV

BGS articolo	DESCRIZIONE	Euro
BGS 5021	SET 34 PEZZI, CHIAVI A BUSSOLA TORX	63,62

CARATTERISTICHE

- satinare cromate
- 11 chiavi a bussola attacco 3/8": T10 - T60
- 10 inserti Torx c/foro attacco 5/16": T10 - T55
- 1 adattatore per inserti attacco da 3/8"
- 12 bussole Torx E4 - E20

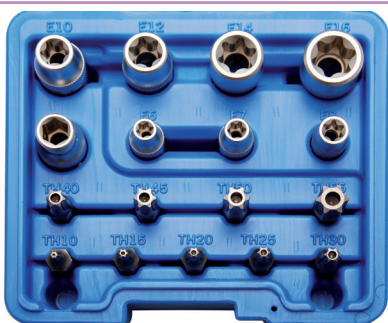

TORX®
TORX® CON FORO

1/4"-3/8"

ESAGONO 5/16" C



TORX®

PRO+

CV

BGS articolo	DESCRIZIONE	Euro
BGS 5023	SET 17 PEZZI, BUSSOLE E INSERTI TORX	29,23

CARATTERISTICHE

- bussole
 - attacco 1/4": E 6-7-8
 - attacco 3/8": E 10-12-14-16
- 9 inserti Torx c/foro attacco esagonale 5/16": TH 10-15-20-25-30-40-45-50-55
- adattatore portainseri attacco quadro 3/8" x 5/16" esagonale

RICAMBI

BGS articolo	DESCRIZIONE	Euro
BGS 5023-LEER	CASSETTA VUOTA	7,14



1/4"-3/8"-1/2"



TORX®

- 5 BUSSOLE TORX® FEMMINA ATT. 1/4" E 4-5-6-7-8
- 5 BUSSOLE TORX® FEMMINA ATT. 3/8" E 10-11-12-14-16
- 4 BUSSOLE TORX® FEMMINA ATT. 1/2" E 18-20-22-24

Attacco: 1/4" - 3/8" - 1/2"
impronta: TORX®

BGS articolo	Descrizione	Euro
54214	CASSETTA PLASTICA 14 PEZZI	44,10

TORX®	S mm	S mm	
E 4	3.70	E 16	14.60
E 5	4.60	E 18	16.50
E 6	5.60	E 20	18.30
E 7	6.10	E 22	20.10
E 8	7.40	E 24	22.00
E 10	9.30	E 26	23.70
E 11	9.90	E 28	25.50
E 12	11.00	E 30	27.30
E 14	12.80	E 32	29.00



1/4"-3/8"-1/2"-3/4" 1/4"-3/8"-1/2"-3/4"

RACCORDI DI RIDUZIONE CHROM-VANADIUM

attacco: 1/4" - 3/8" - 1/2" - 3/4"

BGS articolo	FEMMINA	MASCHIO	Euro
BGS 271	1/4"	3/8"	3,15
BGS 269	3/8"	1/4"	3,15
BGS 280	3/8"	1/2"	3,68
BGS 270	1/2"	3/8"	3,68
BGS 272	1/2"	3/4"	8,40
BGS 274	3/4"	1/2"	8,40



PRO+

CV

BGS articolo	DESCRIZIONE	Euro
BGS 199	SET 6 PEZZI ADATTATORI	24,23

CARATTERISTICHE

- cromati satinati

CONTENUTO

- 1/4" F X 3/8" M, coppia massima 60 Nm
- 3/8" F X 1/4" M, coppia massima 60 Nm
- 3/8" F X 1/2" M, coppia massima 200 Nm
- 1/2" F X 3/8" M, coppia massima 200 Nm
- 1/2" F X 3/4" M, coppia massima 500 Nm
- 3/4" F X 1/2" M, coppia massima 500 Nm

RICAMBI

BGS articolo	DESCRIZIONE	Euro
BGS 199-LEER	CASSETTA VUOTA	5,36

4x

Steckschlüssel-Adapter-Satz

6.3 1/4" x 10 3/8"
10 3/8" x 6.3 1/4"
10 3/8" x 12.5 1/2"
12.5 1/2" x 10 3/8"



Tipps + Trends

Art. 8808

TORX®
1/4"-3/8"-1/2"

BGS articolo	DESCRIZIONE	Euro
BGS 8808	SET 4 PEZZI, RIDUZIONI	10,25

CARATTERISTICHE

- comprende 4 riduzioni:
 - 1/4" F - 3/8" M
 - 3/8" F - 1/4" M
 - 3/8" F - 1/2" M
 - 1/2" F - 3/8" M
- finitura cromata satinata

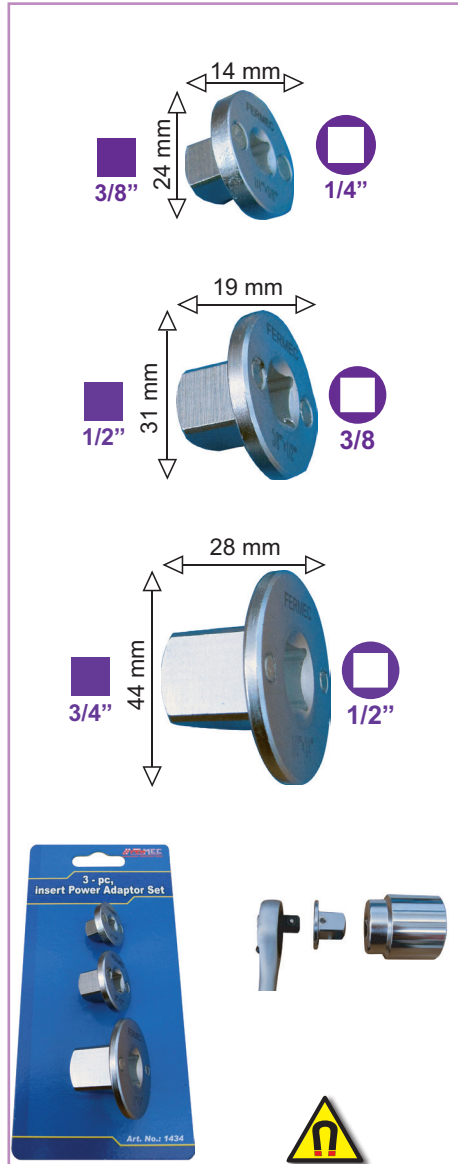

**RACCORDI DI RIDUZIONE MAGNETICI
A SCOMPARSA IDEALI PER CHIAVI
DINAMOMETRICHE E SPAZI RIDOTTI**

attacco: 1/4"-3/8"-1/2"

articolo	FEMMINA	MASCHIO		Euro
1434-1/4	1/4"	3/8"	1	8,93
1434-3/8	3/8"	1/2"	1	9,98
1434-1/2	1/2"	3/4"	1	11,03
1434	SET DA 3 PEZZI IN BLISTER		1	28,35

NOTE

Dotted lines for note-taking.



3/8

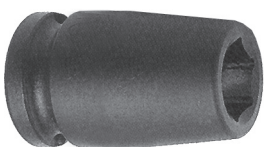

ESAGONO

BUSSOLE POWER IMPACT

attacco: 3/8"

impronta: ESAGONO

FEARMEC articolo	mm	L mm		Euro
196-6	6	30	1	6,55
196-7	7	30	1	6,55
196-8	8	30	1	6,55
196-9	9	30	1	6,55
196-10	10	30	1	6,55
196-11	11	30	1	6,55
196-12	12	30	1	6,55
196-13	13	30	1	6,93
196-14	14	30	1	6,93
196-15	15	30	1	6,93
196-16	16	30	1	6,93
196-17	17	30	1	6,93
196-18	18	30	1	7,46
196-19	19	30	1	7,46
196-20	20	30	1	7,57
196-21	21	30	1	7,94
196-22	22	30	1	8,69
196-23	23	30	1	10,08
196-24	24	30	1	10,86



ESAGONO

CHIAVI A BUSSOLA A MACCHINA BOCCA ESAGONALE

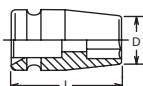

Kokon articolo	mm	D mm	L mm		Euro
13400M-6	6	10.8	32	1	7,84
13400M-7	7	12	32	1	7,84
13400M-8	8	13.3	32	1	7,84
13400M-9	9	14.5	32	1	7,84
13400M-10	10	15.8	32	1	7,84
13400M-11	11	17	32	1	7,84
13400M-12	12	18.3	32	1	7,84
13400M-13	13	19.5	32	1	8,36
13400M-14	14	20.8	32	1	8,36
13400M-15	15	22	32	1	8,36
13400M-16	16	23.3	32	1	8,36
13400M-17	17	24.5	32	1	8,36
13400M-18	18	25.8	32	1	8,94
13400M-19	19	27	32	1	8,94
13400M-20	20	28.3	32	1	9,46
13400M-21	21	29.5	32	1	9,79
13400M-22	22	30.8	32	1	10,84
13400M-23	23	32	32	1	12,54
13400M-24	24	33.3	32	1	13,64



Kokon articolo	DESCRIZIONE	Euro
13241M	Set chiavi a bussola 11 Pezzi in cassetta metallica	101,75
RICAMBI		
BUSSOLE ESAGONO	13400M 9, 10, 11, 12, 13, 14, 15, 16, 17, 18, 19	



Kokon articolo	DESCRIZIONE	Euro
13242M	Set chiavi a bussola 11 Pezzi in cassetta metallica 310 x 90 x h 48 mm con scomparto portautensili vuoto	115,20
RICAMBI		
BUSSOLE ESAGONO	13400M 9, 10, 11, 12, 13, 14, 15, 16, 17, 18, 19	



ESAGONO

CHIAVI A BUSSOLA A MACCHINA BOCCA ESAGONALE CON RIVESTIMENTO

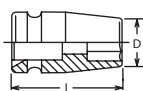

Kokon articolo	mm	D mm	L mm		Euro
13400M-8FR	8	15.7	32	1	58,66
13400M-10FR	10	18.2	32	1	58,66
13400M-12FR	12	20.8	32	1	58,66
13400M-13FR	13	23.6	32	1	67,07
13400M-14FR	14	21.8	32	1	67,07
13400M-16FR	16	26.1	32	1	67,07
13400M-17FR	17	27.3	32	1	67,07

POLLICI



ESAGONO

CHIAVI A BUSSOLA A MACCHINA BOCCA ESAGONALE

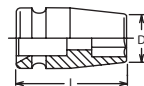

Kokon articolo	pollici	D mm	L mm		Euro
13400A-1/4	1/4"	10.8	32	1	8,42
13400A-5/16	5/16"	13.3	32	1	8,42
13400A-3/8	3/8"	15.8	32	1	8,42
13400A-7/16	7/16"	17	32	1	8,42
13400A-1/2	1/2"	19.5	32	1	9,02
13400A-9/16	9/16"	20.8	32	1	9,02
13400A-5/8	5/8"	23.3	32	1	9,02
13400A-11/16	11/16"	24.5	32	1	9,60
13400A-3/4	3/4"	27	32	1	9,60
13400A-13/16	13/16"	29.5	32	1	10,56
13400A-7/8	7/8"	30.8	32	1	11,66



ESAGONO

CHIAVI A BUSSOLA A MACCHINA BOCCA ESAGONALE CON MAGNETE

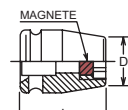

Kokon articolo	mm	D mm	L mm			Euro
13400MG-6	6	10.8	32	1		13,17
13400MG-7	7	12	32	1		13,42
13400MG-8	8	13.3	32	1		13,86
13400MG-9	9	14.5	32	1		13,86
13400MG-10	10	15.8	32	1		14,16
13400MG-11	11	17	32	1		14,16
13400MG-12	12	18.3	32	1		14,16
13400MG-13	13	19.5	32	1		14,33
13400MG-14	14	20.8	32	1		20,68
13400MG-15	15	22	32	1		20,96
13400MG-16	16	23.3	32	1		22,00
13400MG-17	17	24.5	32	1		22,00
13400MG-18	18	25.8	32	1		23,51
13400MG-19	19	27	32	1		23,98
13400MG-21	21	29.5	32	1		39,93
13400MG-22	22	30.8	32	1		40,56



POLLICI



ESAGONO

CHIAVI A BUSSOLA
A MACCHINA EXTRA CORTE
RIBASSATE
BOCCA ESAGONALE



Koken articolo	mm	D mm	L mm	Euro
13401MS-8	8	12.3	22	18,18
13401MS-10	10	14.8	22	18,18
13401MS-12	12	17.3	22	18,18
13401MS-13	13	18.5	22	19,11
13401MS-14	14	19.8	22	19,11

POLIGONALE



POLIGONALE

CHIAVI A BUSSOLA
A MACCHINA
BOCCA POLIGONALE

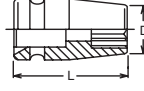

Koken articolo	pollici	D mm	L mm	Euro
13405A-1/4	1/4"	10.8	32	8,86
13405A-5/16	5/16"	13.3	32	8,86
13405A-3/8	3/8"	15.8	32	8,86
13405A-7/16	7/16"	17	32	8,86
13405A-1/2	1/2"	19.5	32	9,43
13405A-9/16	9/16"	20.8	32	9,43
13405A-5/8	5/8"	23.3	32	9,43
13405A-11/16	11/16"	24.5	32	10,15
13405A-3/4	3/4"	27	32	10,15
13405A-13/16	13/16"	29.5	32	11,08
13405A-7/8	7/8"	30.8	32	12,24

SURFACE DRIVE



SURFACE DRIVE

CHIAVI A BUSSOLA
A MACCHINA BOCCA
SURFACE DRIVE

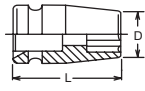

Koken articolo	mm	D mm	L mm	Euro
13410M-6	6	10.8	32	8,20
13410M-7	7	12	32	8,20
13410M-8	8	13.3	32	8,20
13410M-9	9	14.5	32	8,20
13410M-10	10	15.8	32	8,20
13410M-11	11	17	32	8,20
13410M-12	12	18.3	32	8,20
13410M-13	13	19	32	8,77
13410M-14	14	20.8	32	8,77
13410M-15	15	22	32	8,77
13410M-16	16	23.3	32	8,77
13410M-17	17	24.5	32	8,77
13410M-18	18	25.8	32	9,35
13410M-19	19	27	32	9,35
13410M-22	22	30.8	32	11,36

POLIGONALE



POLIGONALE

CHIAVI A BUSSOLA
A MACCHINA
BOCCA POLIGONALE

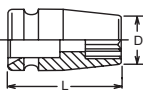

Koken articolo	mm	D mm	L mm	Euro
13405M-8	8	13.3	32	8,42
13405M-9	9	14.5	32	8,42
13405M-10	10	15.8	32	8,42
13405M-11	11	17	32	8,42
13405M-12	12	18.3	32	8,42
13405M-13	13	19.5	32	9,02
13405M-14	14	20.8	32	9,02
13405M-15	15	22	32	9,02
13405M-16	16	23.3	32	9,02
13405M-17	17	24.5	32	9,02
13405M-18	18	25.8	32	9,60
13405M-19	19	27	32	9,60

PARETI SOTTILI



POLIGONALE

CHIAVI A BUSSOLA
A MACCHINA
BOCCA POLIGONALE
PARETI SOTTILI

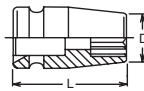

Koken articolo	mm	D mm	L mm	Euro
13406M-6	6	9.8	32	8,42
13406M-7	7	11	32	8,42
13406M-8	8	12.3	32	8,42
13406M-9	9	13.5	32	8,42
13406M-10	10	14.8	32	8,42
13406M-11	11	16	32	8,42
13406M-12	12	17.3	32	8,42
13406M-13	13	18.5	32	9,02
13406M-14	14	19.8	32	9,02
13406M-15	15	21	32	9,02
13406M-16	16	22.3	32	9,02
13406M-17	17	23.5	32	9,02
13406M-18	18	24.8	32	9,60
13406M-19	19	26	32	9,60
13406M-20	20	27.3	32	10,18
13406M-21	21	28.5	32	10,56
13406M-22	22	29.8	32	11,66
13406M-23	23	31	32	13,53
13406M-24	24	32.3	32	14,66

FAST LEAD



FAST LEAD

CHIAVI A BUSSOLA
A MACCHINA BOCCA
FAST LEAD

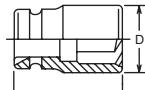

Koken articolo	mm	D mm	L mm	Euro
13465M-8	8	13.3	32	12,90
13465M-10	10	15.8	32	12,90
13465M-11	11	17	32	12,90
13465M-12	12	18.3	32	12,90
13465M-13	13	19.5	32	12,90
13465M-14	14	20.8	32	12,90
13465M-15	15	22	32	12,90
13465M-16	16	23.3	32	13,23
13465M-17	17	24.5	32	13,23
13465M-18	18	25.8	32	13,23
13465M-19	19	27	32	13,94



IMPACT 3/8"



CHIAVI A BUSSOLA A MACCHINA BOCCA LHSTIX®

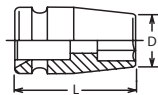

Kokon articolo	Logo	D mm	L mm	Box	Euro
13401LH-5S	5S	11	32	1	13,64
13401LH-6S	6S	12.3	32	1	13,64
13401LH-8S	8S	16	32	1	13,64
13401LH-10S	10S	18.5	32	1	14,08
13401LH-12S	12S	22.3	32	1	14,71
13401LH-14S	14S	24.8	32	1	15,62
13401LH-16S	16S	28.5	32	1	16,80

LHSTIX®	d mm	D mm
LH 3 S	3.80	4.70
LH 4 S	4.50	6.00
LH 5 S	5.60	7.50
LH 6 S	6.80	9.00
LH 7 S	7.90	10.50
LH 8 S	9.00	12.00
LH 10 S	11.30	15.00
LH 12 S	13.60	18.00
LH 14 S	15.80	21.00
LH 16 S	18.10	24.00



CHIAVI A BUSSOLA A MACCHINA BOCCA TORX®

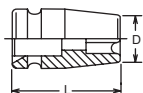

Kokon articolo	Logo	D mm	L mm	Box	Euro
13425-E 4	E 4	9.7	32	1	9,82
13425-E 5	E 5	10.2	32	1	9,82
13425-E 6	E 6	10.7	32	1	9,82
13425-E 7	E 7	11.2	32	1	9,82
13425-E 8	E 8	11.7	32	1	9,82
13425-E10	E10	12.2	32	1	9,82
NEW 13425-E11	E11	13.2	32	1	9,82
13425-E12	E12	14.2	32	1	9,82
13425-E14	E14	17.2	32	1	9,82
13425-E16	E16	18.2	32	1	10,04

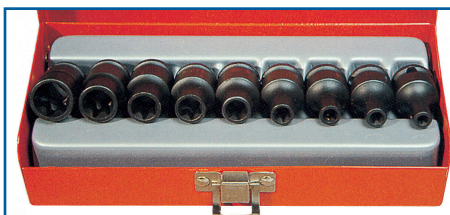

DESCRIZIONE	Euro
Set chiavi a bussola 9 Pezzi in cassetta metallica	63,00

CARATTERISTICHE
E 5-6-7-8-10-11-12-14-16



CHIAVI A BUSSOLA A MACCHINA BOCCA TORX PLUS®

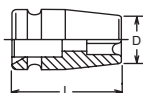

Kokon articolo	Logo	D mm	L mm	Box	Euro
13425-8EPL	8	12	32	1	19,77
13425-10EPL	10	13.3	32	1	19,77
NEW 13425-12EPL	12	15.8	32	1	22,22
NEW 13425-14EPL	14	18.3	32	1	22,22
NEW 13425-16EPL	16	19.5	32	1	22,22

TORX PLUS®	S mm	S mm	
E 4	3.70	E 16	14.60
E 5	4.60	E 18	16.50
E 6	5.60	E 20	18.30
E 7	6.10	E 22	20.10
E 8	7.40	E 24	22.00
E 10	9.30	E 26	23.70
E 11	9.90	E 28	25.50
E 12	11.00	E 30	27.30
E 14	12.80	E 32	29.00



CHIAVI A BUSSOLA A MACCHINA BOCCA QUADRA

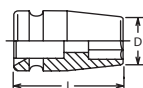

Kokon articolo	Logo	D mm	L mm	Box	Euro
13400WN-6	6	15.8	32	1	35,70
13400WN-8	8	18.3	32	1	35,70
13400WN-9	9	19.5	32	1	35,70
13400WN-10	10	20.8	32	1	35,70
13400WN-12	12	24.5	32	1	36,82
13400WN-14	14	27	32	1	36,82
13400WN-17	17	32	32	1	38,39

PARETI SOTTILI SU TUTTO IL CORPO



CHIAVI A BUSSOLA POWER BOCCA ESAGONALE

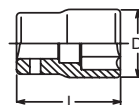

Kokon articolo	Logo	D mm	L mm	Box	Euro
23400M-6	6	9.9	26	1	6,22
23400M-7	7	10.8	26	1	6,22
23400M-8	8	13.9	26	1	6,22
23400M-10	10	14.5	26	1	6,22
23400M-11	11	15.8	26	1	6,22
23400M-12	12	16.8	26	1	6,22
23400M-13	13	18	26	1	6,85
23400M-14	14	19.5	27	1	6,90
23400M-15	15	20.8	28	1	7,01
23400M-16	16	22	28	1	7,01
23400M-17	17	23.4	29	1	7,01
23400M-18	18	24.5	30	1	7,01
23400M-19	19	25.8	30	1	7,01
23400M-21	21	28	32	1	9,57

PARETI SOTTILI SU TUTTO IL CORPO



CHIAVI A BUSSOLA POWER BOCCA ESAGONALE

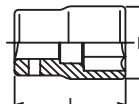

Kokon articolo	Logo	D pollici	D mm	L mm	Box	Euro
23400A-5/16	5/16"	12	26	1	6,71	
23400A-3/8	3/8"	13.9	26	1	6,71	
23400A-7/16	7/16"	15.8	26	1	6,71	
23400A-1/2	1/2"	18	26	1	7,40	
23400A-9/16	9/16"	19.5	27	1	7,45	
23400A-11/16	11/16"	24.5	30	1	7,56	
23400A-3/4	3/4"	25.8	30	1	7,56	

PARETI SOTTILI SU TUTTO IL CORPO



CHIAVI A BUSSOLA POWER BOCCA POLIGONALE

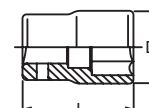

Kokon articolo	Logo	D mm	L mm	Box	Euro
23405M-8	8	12	26	1	6,55
23405M-10	10	14.5	26	1	6,55
23405M-12	12	16.8	26	1	6,55
23405M-14	14	19.5	27	1	7,62

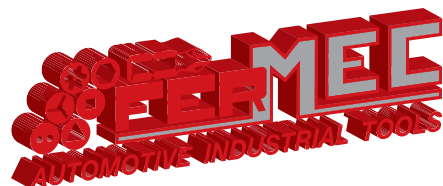



PARETI SOTTILI
SU TUTTO IL CORPO



**SURFACE
DRIVE**

CHIAVI A BUSSOLA
POWER
BOCCA SURFACE DRIVE

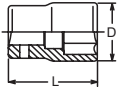

Koken articolo	mm	D mm	L mm	Euro
23410M-8	8	12	26	6,55
23410M-10	10	14.5	26	6,55
23410M-12	12	16.8	26	6,55
23410M-13	13	18	26	7,62
23410M-14	14	19.5	27	7,62
23410M-15	15	21	28	8,17
23410M-16	16	22	28	8,17
23410M-17	17	23.5	29	8,17
23410M-18	18	24.6	30	8,47
23410M-19	19	26	30	8,47

PARETI SOTTILI
SU TUTTO IL CORPO



TORX®

CHIAVI A BUSSOLA
POWER
BOCCA TORX®

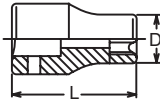

Koken articolo	mm	D mm	L mm	Euro
23425-E 5	E 5	10.2	26	7,32
23425-E 6	E 6	10.7	26	7,32
23425-E 7	E 7	11.2	26	7,32
23425-E 8	E 8	11.7	26	7,32
23425-E10	E10	12.2	26	7,32
23425-E11	E11	13.3	26	7,32
23425-E12	E12	14.2	26	7,32
23425-E14	E14	17.2	26	7,32
23425-E16	E16	18.2	26	7,73

TORX®	S mm	S mm	
E 4	3.70	E 16	14.60
E 5	4.60	E 18	16.50
E 6	5.60	E 20	18.30
E 7	6.10	E 22	20.10
E 8	7.40	E 24	22.00
E 10	9.30	E 26	23.70
E 11	9.90	E 28	25.50
E 12	11.00	E 30	27.30
E 14	12.80	E 32	29.00



3/8

ESAGONO

LUNGHE

attacco: 3/8"
impronta: ESAGONO

Koken articolo	mm	L mm	Euro
196-8 L	8	65	11,47
196-9 L	9	65	11,47
196-10 L	10	65	11,47
196-11 L	11	65	11,47
196-12 L	12	65	11,47
196-13 L	13	65	13,28
196-14 L	14	65	13,28
196-15 L	15	65	13,28
196-16 L	16	65	13,28
196-17 L	17	65	13,28
196-18 L	18	65	13,28
196-19 L	19	65	13,28
196-20 L	20	65	15,70
196-21 L	21	65	15,70
196-22 L	22	65	16,30
196-23 L	23	65	16,30



ESAGONO

CHIAVI A BUSSOLA
A MACCHINA BOCCA
ESAGONALE
TIPO LUNGO

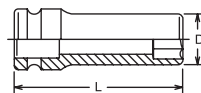

Koken articolo	mm	D mm	L mm	Euro
13300M-6	6	10.8	80	13,53
13300M-7	7	12	80	13,53
13300M-8	8	13.3	80	13,53
13300M-9	9	14.5	80	13,53
13300M-10	10	15.8	80	13,53
13300M-11	11	17	80	13,53
13300M-12	12	18.3	80	13,53
13300M-13	13	19.5	80	14,99
13300M-14	14	20.8	80	14,99
13300M-15	15	22	80	14,99
13300M-16	16	23.3	80	14,99
13300M-17	17	24.5	80	14,99
13300M-18	18	25.8	80	15,35
13300M-19	19	27	80	17,99
13300M-20	20	28.3	80	18,29
13300M-21	21	29.5	80	19,22
13300M-22	22	30.8	80	20,43
13300M-24	24	33.2	80	23,07

POLLICI



ESAGONO

CHIAVI A BUSSOLA
A MACCHINA BOCCA
ESAGONALE
TIPO LUNGO

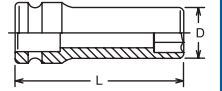

Koken articolo	pollici	D mm	L mm	Euro
13300A-1/4	1/4"	10.8	80	14,58
13300A-5/16	5/16"	13.3	80	14,58
13300A-3/8	3/8"	15.8	80	14,58
13300A-7/16	7/16"	17	80	14,58
13300A-1/2	1/2"	19.5	80	16,20
13300A-9/16	9/16"	20.8	80	16,20
13300A-5/8	5/8"	23.3	80	16,20
13300A-11/16	11/16"	24.5	80	16,56
13300A-3/4	3/4"	27	80	19,42
13300A-13/16	13/16"	29.5	80	20,71
13300A-7/8	7/8"	30.8	80	22,03

PARETI SOTTILI



ESAGONO

CHIAVI A BUSSOLA
A MACCHINA BOCCA
ESAGONALE
TIPO LUNGO
PARETI SOTTILI

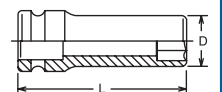

Koken articolo	mm	D mm	L mm	Euro
13301M-6	6	10	80	13,89
13301M-7	7	11	80	13,89
13301M-8	8	12.3	80	13,89
13301M-9	9	13.5	80	13,89
13301M-10	10	14.8	80	13,89
13301M-11	11	16	80	13,89
13301M-12	12	17.3	80	13,89
13301M-13	13	18.5	80	15,40
13301M-14	14	19.8	80	15,40
13301M-15	15	21	80	15,40
13301M-16	16	22.3	80	15,40
13301M-17	17	23.5	80	15,40
13301M-18	18	24.8	80	15,76
13301M-19	19	26	80	18,45
13301M-20	20	23.7	80	18,78
13301M-21	21	28.5	80	19,75
13301M-22	22	29.8	80	20,96
13301M-24	24	32.3	80	23,68

IMPACT 3/8"

PARETI SOTTILI SEMI-LUNGA



ESAGONO

CHIAVI A BUSSOLA
A MACCHINA BOCCA
ESAGONALE
PARETI SOTTILI
TIPO SEMI-LUNGO

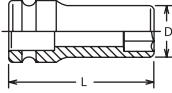

Koken articolo	mm	D mm	L mm	Euro
13301X-7	7	11	50	12,84
13301X-8	8	12.3	50	12,84
13301X-10	10	14.8	50	12,84
13301X-11	11	16	50	12,84
13301X-12	12	17.3	50	12,84
13301X-13	13	18.5	50	14,27
13301X-14	14	19.8	50	14,27
13301X-15	15	21	50	14,27
13301X-16	16	22.3	50	14,27
13301X-17	17	23.5	50	14,55
13301X-18	18	24.8	50	16,36
13301X-19	19	26	50	16,80
13301X-21	21	28.5	50	17,93
13301X-22	22	29.8	50	19,22
13301X-23	23	31	50	20,68
13301X-24	24	32.3	50	21,20



SURFACE DRIVE

CHIAVI A BUSSOLA
A MACCHINA BOCCA
SURFACE DRIVE
TIPO LUNGO

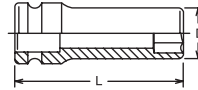

Koken articolo	mm	D mm	L mm	Euro
13310M-7	7	11	80	14,22
13310M-8	8	13.3	80	14,22
13310M-9	9	14.5	80	14,22
13310M-10	10	15.8	80	14,22
13310M-11	11	17	80	14,22
13310M-12	12	18.3	80	14,22
13310M-13	13	19.5	80	15,79
13310M-14	14	20.8	80	15,79
13310M-15	15	22	80	15,79
13310M-16	16	23.3	80	15,79
13310M-17	17	24.5	80	15,79
13310M-18	18	25.8	80	18,51
13310M-19	19	27	80	18,92

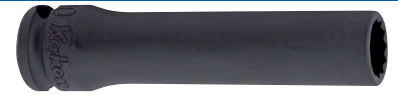

POLIGONALE

CHIAVI A BUSSOLA
A MACCHINA BOCCA
POLIGONALE
TIPO LUNGO

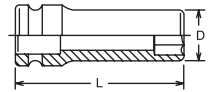

Koken articolo	mm	D mm	L mm	Euro
13305M-8	8	13.3	80	14,16
13305M-10	10	15.8	80	14,16
13305M-11	11	17	80	14,16
13305M-12	12	18.3	80	14,16
13305M-13	13	19.5	80	15,68
13305M-14	14	20.8	80	15,68
13305M-17	17	24.5	80	15,68

IMPACT 3/8"

PARETI SOTTILI NEW



POLIGONALE

CHIAVI A BUSSOLA
A MACCHINA BOCCA
POLIGONALE
TIPO LUNGO
PARETI SOTTILI

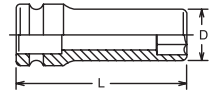

Koken articolo	mm	D mm	L mm	Euro
13306M-8	8	12.3	80	14,16
13306M-10	10	14.8	80	14,16
13306M-11	11	16	80	14,16
13306M-12	12	17.3	80	14,16
13306M-13	13	18.5	80	15,68
13306M-14	14	19.8	80	15,68
13306M-17	17	23.5	80	15,68



ESAGONO



CHIAVI A BUSSOLA
A MACCHINA BOCCA
ESAGONALE
CON MAGNETE
RETRATTILE

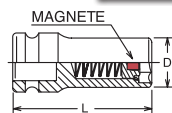

Koken articolo	mm	D mm	L mm	Euro
13300XG-7	7	12	50	26,24
13300XG-8	8	13.3	50	26,24
13300XG-10	10	15.8	50	26,24
13300XG11	11	17	50	26,24
13300XG-12	12	18.3	50	26,24
13300XG-13	13	19.5	50	29,45
13300XG-14	14	20.8	50	29,59
13300G-8	8	13.3	80	28,22
13300G-10	10	15.8	80	28,22
13300G-12	12	18.3	80	28,22
13300G-13	13	19.5	80	31,19
13300G-14	14	20.8	80	31,19
13300G-15	15	22	80	31,52
13300G-16	16	23.3	80	31,52
13300G-17	17	24.5	80	31,52
13300G-19	19	27	80	44,11



FAST LEAD

CHIAVI A BUSSOLA
A MACCHINA BOCCA
FAST LEAD
TIPO LUNGO

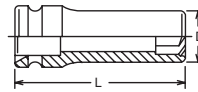

Koken articolo	mm	D mm	L mm	Euro
13365M-8	8	13.3	80	18,56
13365M-10	10	15.8	80	18,56
13365M-11	11	17	80	18,56
13365M-12	12	18.3	80	18,56
13365M-13	13	19.5	80	19,22
13365M-14	14	20.8	80	19,22
13365M-15	15	22	80	19,22
13365M-16	16	23.3	80	19,22
13365M-17	17	24.5	80	19,22
13365M-18	18	25.8	80	20,43
13365M-19	19	27	80	20,43





CHIAVI A BUSSOLA
POWER
BOCCA ESAGONALE
TIPO LUNGO

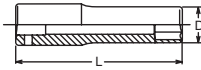

Koken articolo	mm	D mm	L mm		Euro
23300M-7	7	10.6	55	1	10,81
23300M-8	8	12	55	1	10,81
23300M-10	10	14.5	55	1	10,81
23300M-11	11	16	55	1	10,81
23300M-12	12	16.8	55	1	10,81
23300M-13	13	18	55	1	11,77
23300M-14	14	20	55	1	11,77
23300M-15	15	21	55	1	11,77
23300M-16	16	22	55	1	11,77
23300M-17	17	23.5	55	1	11,77
23300M-18	18	24.5	55	1	13,59
23300M-19	19	25	55	1	13,59



CHIAVI A BUSSOLA
POWER
BOCCA ESAGONALE
TIPO LUNGO

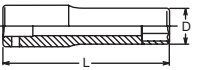

Koken articolo	pollici	D mm	L mm		Euro
23300A-5/16	5/16"	12	55	1	10,01
23300A-3/8	3/8"	14	55	1	10,09
23300A-7/16	7/16"	16	55	1	11,63
23300A-1/2	1/2"	18	55	1	12,65
23300A-9/16	9/16"	20	55	1	12,65
23300A-11/16	11/16"	23.5	55	1	14,63
23300A-3/4	3/4"	25	55	1	14,63



CHIAVI A BUSSOLA
POWER
BOCCA POLIGONALE
TIPO LUNGO

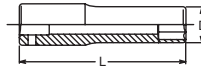

Koken articolo	mm	D mm	L mm		Euro
23305M-8	8	12	55	1	11,96
23305M-10	10	14.5	55	1	11,96
23305M-12	12	16.8	55	1	11,96
23305M-14	14	20	55	1	13,42



CHIAVI A BUSSOLA
POWER
BOCCA SURFACE
DRIVE TIPO LUNGO

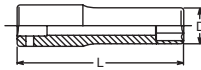

Koken articolo	mm	D mm	L mm		Euro
23310M-8	8	12	55	1	11,96
23310M-10	10	14.5	55	1	11,96
23310M-12	12	16.8	55	1	11,96
23310M-13	13	18	55	1	13,42
23310M-14	14	19.5	55	1	13,42
23310M-15	15	21	55	1	13,42
23310M-17	17	23.5	55	1	13,42



CHIAVI A BUSSOLA
POWER
BOCCA TORX®
TIPO LUNGO

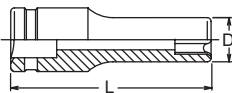

Koken articolo		D mm	L mm		Euro
23325-E 5	E 5	10.2	55	1	12,49
23325-E 6	E 6	10.7	55	1	12,49
23325-E 7	E 7	11.2	55	1	12,49
23325-E 8	E 8	11.7	55	1	12,49
23325-E10	E10	12.2	55	1	12,49
23325-E12	E12	14.2	55	1	12,49
23325-E14	E14	17.2	55	1	12,49
23325-E16	E16	18.2	55	1	13,23



CHIAVI A BUSSOLA
A MACCHINA BOCCA
ESAGONALE
TIPO EXTRA LUNGO

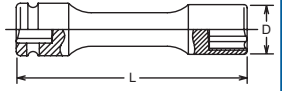

Koken articolo	mm	D mm	L mm		Euro
13145M-100-8	8	13.3	100	1	24,78
13145M-100-10	10	15.8	100	1	24,78
13145M-100-12	12	18.3	100	1	24,78
13145M-100-13	13	19.5	100	1	29,21
13145M-100-14	14	20.8	100	1	29,21
13145M-100-17	17	24.5	100	1	29,21
13145M-150-6	6	10.8	150	1	32,23
13145M-150-8	8	13.3	150	1	32,23
13145M-150-10	10	15.8	150	1	32,23
13145M-150-12	12	18.3	150	1	32,23
13145M-150-13	13	19.5	150	1	33,03
13145M-150-14	14	20.8	150	1	33,03
13145M-150-15	15	22	150	1	33,03
13145M-150-17	17	24.5	150	1	33,03
13145M-200-6	6	10.8	200	1	36,47
13145M-200-8	8	13.3	200	1	36,47
13145M-200-10	10	15.8	200	1	36,47
13145M-200-12	12	18.3	200	1	36,47
13145M-200-13	13	19.5	200	1	36,63
13145M-200-14	14	20.8	200	1	36,63
13145M-200-15	15	22	200	1	36,63
13145M-200-17	17	24.5	200	1	36,63
13145M-250-6	6	10.8	250	1	37,32
13145M-250-8	8	13.3	250	1	37,32
13145M-250-10	10	15.8	250	1	37,32
13145M-250-12	12	18.3	250	1	37,32
13145M-250-13	13	19.5	250	1	37,46
13145M-250-14	14	20.8	250	1	37,46
13145M-250-15	15	22	250	1	37,46
13145M-250-17	17	24.5	250	1	37,46
13145A-150-9/16	9/16"	20	150	1	38,17

POLLICI

TORX®		S mm	S mm	
	E 4	3.70	E 16	14.60
	E 5	4.60	E 18	16.50
	E 6	5.60	E 20	18.30
	E 7	6.10	E 22	20.10
	E 8	7.40	E 24	22.00
	E 10	9.30	E 26	23.70
	E 11	9.90	E 28	25.50
	E 12	11.00	E 30	27.30
	E 14	12.80	E 32	29.00



CHIAVI A
BUSSOLA
A MACCHINA
BOCCA
ESAGONALE
TIPO EXTRA
LUNGO CON
MAGNETE

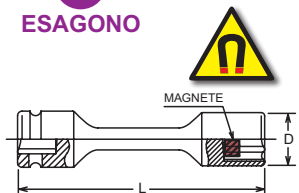

Koken articolo	mm	D mm	L mm		Euro
13145MG-100-8	8	13.3	100	1	52,09
13145MG-100-10	10	15.8	100	1	52,09
13145MG-100-12	12	18.3	100	1	53,57
13145MG-100-13	13	20.8	100	1	57,61
13145MG-100-14	14	20.8	100	1	57,61
13145MG-150-10	10	15.8	150	1	60,67
13145MG-150-12	12	18.3	150	1	61,71
13145MG-150-13	13	20.8	150	1	64,05
13145MG-150-14	14	24.5	150	1	64,05
13145MG-200-10	10	15.8	200	1	62,59
13145MG-200-12	12	18.3	200	1	62,59
13145MG-200-13	13	20.8	200	1	66,47
13145MG-200-14	14	24.5	200	1	66,47



CHIAVI A
BUSSOLA
A MACCHINA
BOCCA
POLIGONALE 12
PUNTI
EXTRA LUNGHE



Koken articolo	mm	D mm	L mm		Euro
13145M-100-12P-10	10	15.8	100	1	27,39
13145M-100-12P-12	12	18.3	100	1	27,39
13145M-150-12P-10	10	15.8	150	1	34,16
13145M-150-12P-12	12	18.3	150	1	34,16
13145M-200-12P-10	10	15.8	200	1	37,68
13145M-200-12P-12	12	18.3	200	1	37,68



CHIAVI A BUSSOLA
A MACCHINA
BOCCA
ESAGONALE
TIPO EXTRA
LUNGO SNODATA

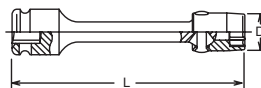

Koken articolo	mm	D mm	L mm		Euro
13146M-150-8	8	12	150	1	60,01
13146M-150-10	10	14.3	150	1	60,01
13146M-150-12	12	18	150	1	60,01
13146M-150-13	13	19.3	150	1	60,01
13146M-150-14	14	20	150	1	60,01
13146M-200-8	8	12	200	1	63,55
13146M-200-10	10	14.3	200	1	63,55
13146M-200-12	12	18	200	1	63,55
13146M-200-13	13	19.3	200	1	63,55
13146M-200-14	14	20	200	1	63,55
13146M-250-8	8	12	250	1	64,68
13146M-250-10	10	14.3	250	1	64,68
13146M-250-12	12	18	250	1	64,68
13146M-250-13	13	19.3	250	1	64,68
13146M-250-14	14	20	250	1	64,68



CHIAVI A BUSSOLA
A MACCHINA
SNODATE
BOCCA ESAGONALE

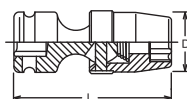

Koken articolo	mm	D mm	L mm		Euro
13440M-10	10	15.8	57	1	40,51
13440M-11	11	17	57	1	40,51
13440M-12	12	18.3	57	1	40,51
13440M-13	13	19.5	57	1	40,51
13440M-14	14	20.8	59	1	40,51
13440M-15	15	22	59	1	40,51
13440M-16	16	23.3	59	1	40,51
13440M-17	17	24.5	59	1	40,51
13440M-18	18	25.8	61	1	41,58
13440M-19	19	27	61	1	41,58
13440M-20	20	29.5	65	1	44,47
13440M-21	21	30.7	65	1	44,72
13440M-22	22	32	65	1	44,99
13440M-24	24	34.5	67	1	44,99

POLLICI



CHIAVI A BUSSOLA
A MACCHINA
SNODATE
BOCCA ESAGONALE

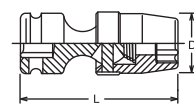

Koken articolo	pollici	D mm	L mm		Euro
13440A-3/8	3/8"	15.8	57	1	43,64
13440A-7/16	7/16"	17	57	1	43,64
13440A-1/2	1/2"	19.5	57	1	43,64
13440A-9/16	9/16"	20.8	59	1	43,64
13440A-5/8	5/8"	23.3	59	1	43,64
13440A-11/16	11/16"	24.5	59	1	44,83
13440A-3/4	3/4"	27	61	1	44,83



CHIAVI A BUSSOLA
A MACCHINA
SNODATE
BOCCA TORX

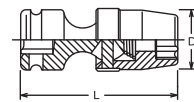

Koken articolo		D mm	L mm		Euro
13440T-E10	E 10	13.3	57.7	1	53,60
13440T-E12	E 12	15.8	57.7	1	53,60
13440T-E14	E 14	17	57.7	1	53,60



3/8"

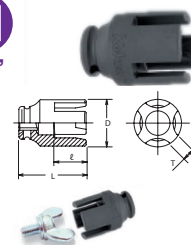

CHIAVE A BUSSOLA PER VITI E DADI CON
ALLETTE - GALLETTO

Koken articolo	T mm	ℓ mm	L mm		Euro
BD018	7,3	21	45	1	25,85



3/8

ESAGONO

BUSSOLE ESAGONALI MASCHIO INTEGRALI

attacco: 3/8"

impronta: ESAGONO MASCHIO

articolo	mm	L mm		Euro
182 - 3/8" - 4 - 36	4	36	1	9,98
182 - 3/8" - 5 - 36	5	36	1	9,98
182 - 3/8" - 6 - 36	6	36	1	9,98
182 - 3/8" - 8 - 36	8	36	1	9,98
182 - 3/8" - 10 - 36	10	36	1	9,98
182 - 3/8" - 4	4	50	1	13,65
182 - 3/8" - 5	5	50	1	13,65
182 - 3/8" - 6	6	50	1	13,65
182 - 3/8" - 7	7	50	1	13,65
182 - 3/8" - 8	8	50	1	13,65
182 - 3/8" - 10	10	50	1	14,70
182 - 3/8" - 12	12	50	1	15,23
182 - 3/8" - 14	14	50	1	16,28
1182 - 3/8" - 4	4	90	1	20,48
1182 - 3/8" - 5	5	90	1	20,48
1182 - 3/8" - 6	6	90	1	20,48
1182 - 3/8" - 8	8	90	1	20,48
2182 - 3/8" - 8	8	125	1	22,48



3/8 ESAGONO

**BUSSOLE IMPACT BRUGOLA
MM 4-5-6-7-8-10-12, LUNGH. 50 MM**

attacco: 3/8"

impronta: ESAGONO MASCHIO

articolo	Descrizione		Euro
511071	CASSETTA METALLICA 7 PEZZI	1	47,25

POLLICI



3/8 ESAGONO

**BUSSOLE IMPACT BRUGOLA
MISURE IN POLLICI - 3/16"-7/32"-1/4"-
9/32"-5/16"-3/8"-7/16" - LUNGH. 50 MM**

attacco: 3/8"

impronta: ESAGONO MASCHIO

articolo	Descrizione		Euro
411071	CASSETTA METALLICA 7 PEZZI	1	47,25



ESAGONO

**CHIAVI A BUSSOLA
A MACCHINA
SNODATE
MASCHIO ESAGONALE**

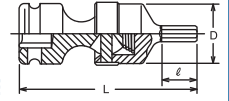

articolo	mm	D mm	l mm	L mm		Euro
13430M-5	5	24	15	74	1	44,72
13430M-6	6	24	15	74	1	44,72
13430M-8	8	24	20	74	1	44,72
13430M-10	10	24	20	74	1	44,72
13430M-17	17	24	7	53	1	55,17



ESAGONO

**CHIAVI A BUSSOLA
A MACCHINA
MASCHIO
ESAGONALE
TIPO EXTRA
LUNGO
SNODATA**

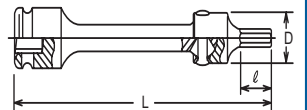

articolo	mm	D mm	l mm	L mm		Euro
13147M-150-4	4	21	15	150	1	62,78
13147M-150-5	5	21	15	150	1	62,78
13147M-150-6	6	21	15	150	1	62,78
13147M-150-8	8	21	15	150	1	62,78
13147M-150-10	10	21	15	150	1	62,78
13147M-200-4	4	21	15	200	1	66,55
13147M-200-5	5	21	15	200	1	66,55
13147M-200-6	6	21	15	200	1	66,55
13147M-200-8	8	21	15	200	1	66,55
13147M-200-10	10	21	15	200	1	66,55



ESAGONO

**CHIAVI A BUSSOLA
A MACCHINA MASCHIO
ESAGONALE - INTEGRALI**

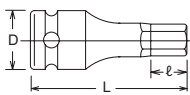

articolo	mm	D mm	l mm	L mm		Euro
13012M-52-3	3	18	10	52	1	14,85
13012M-52-4	4	18	15.5	52	1	14,85
13012M-52-5	5	18	15.5	52	1	14,85
13012M-52-6	6	18	15.5	52	1	14,85
13012M-52-7	7	18	15.5	52	1	15,59
13012M-52-8	8	21	15.5	52	1	15,59
13012M-52-10	10	21	15.5	52	1	15,59
13012M-52-12	12	21	15.5	52	1	17,41
13012M-52-14	14	21	15.5	52	1	20,02



ESAGONO

**SERIE 8 PZ. CHIAVI A BUSSOLA A MACCHINA
MASCHIO ESAGONALE - INTEGRALI**

articolo	mm		Euro
RS13012M/8-L52	4, 5, 6, 7, 8, 10, 12, 14	1	127,85



IMPACT 3/8"

3/8" IMPACT



TORX® IMPACT
attacco: 3/8"
impronta: TX

FEARMEC articolo	TORX	L mm	Box	Euro
184 - 3/8" - 10 GTX TX 10		50	1	13,50
184 - 3/8" - 15 GTX TX 15		50	1	13,50
184 - 3/8" - 20 GTX TX 20		50	1	13,50
184 - 3/8" - 25 GTX TX 25		50	1	13,50
184 - 3/8" - 27 GTX TX 27		50	1	13,50
184 - 3/8" - 30 GTX TX 30		50	1	13,50
184 - 3/8" - 40 GTX TX 40		50	1	13,50
184 - 3/8" - 45 GTX TX 45		50	1	13,50
184 - 3/8" - 50 GTX TX 50		50	1	13,50



TORX®
SERIE 8 PZ. CHIAVI A BUSSOLA A MACCHINA MASCHIO TORX®

Koken articolo	TORX	Box	Euro
RS13025/8-L50	TX 4, 5, 6, 7, 8, 10, 12, 14	1	126,34



NEW
7/16" ESAGONO



INSERTO CON MASCHIO ESAGONALE

Koken articolo	ESAGONO mm	L mm	Box	Euro
183H-35-3	3	35	1	6,90
183H-35-4	4	35	1	6,90
183H-35-5	5	35	1	6,90
183H-35-6	6	35	1	6,90
183H-35-7	7	35	1	7,12
183H-35-8	8	35	1	7,12
183H-35-10	10	35	1	7,12
183H-35-11	11	35	1	11,52
183H-35-12	12	35	1	11,52
183H-35-14	14	35	1	11,96
183H-35-16	16	35	1	11,96
183H-35-17	17	35	1	11,96
183H-35-18	18	35	1	17,77
183H-35-19	19	35	1	17,77
183H-75-3	3	75	1	9,02
183H-75-4	4	75	1	9,02
183H-75-5	5	75	1	9,02
183H-75-6	6	75	1	9,02
183H-75-7	7	75	1	9,02
183H-75-8	8	75	1	9,02
183H-75-10	10	75	1	9,02
183H-75-11	11	75	1	13,09
183H-75-12	12	75	1	13,48
183H-75-14	14	75	1	14,47
183H-150-4	4	150	1	13,75
183H-150-5	5	150	1	13,75
183H-150-6	6	150	1	13,75
183H-150-8	8	150	1	13,75
183H-150-10	10	150	1	13,75
183H-150-12	12	150	1	19,88

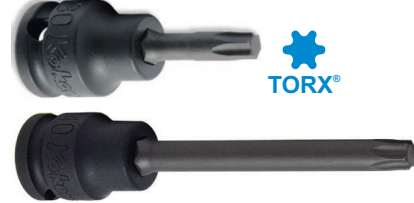

TORX®
CHIAVI A BUSSOLA A MACCHINA MASCHIO TORX®

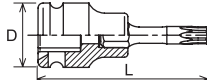

Koken articolo	TORX	D mm	L mm	Box	Euro
13025-50-T20 TX 20		19	50	1	15,59
13025-50-T25 TX 25		19	50	1	15,59
13025-50-T27 TX 27		19	50	1	15,59
13025-50-T30 TX 30		19	50	1	15,59
13025-50-T40 TX 40		19	50	1	15,59
13025-50-T45 TX 45		19	50	1	15,59
13025-50-T50 TX 50		19	50	1	16,80
13025-50-T55 TX 55		22	50	1	19,86
13025-90-T20 TX 20		19	90	1	18,70
13025-90-T25 TX 25		19	90	1	18,70
13025-90-T27 TX 27		19	90	1	18,70
13025-90-T30 TX 30		19	90	1	18,70
13025-90-T40 TX 40		19	90	1	18,70
13025-90-T45 TX 45		19	90	1	18,70
13025-90-T50 TX 50		19	90	1	20,10
13025-90-T55 TX 55		22	90	1	23,82



NEW
13134-SC



BUSSOLA PORTAINSERTI DA 7/16"

Koken articolo	D mm	L mm	Box	Euro
13134	22	32	1	16,14

RICAMBI

Koken articolo	DESCRIZIONE	Euro
13134-SC	GRANO DI RICAMBIO M8X5; ESAGONO 4 MM	1,10



NEW
13142-F11.2



BUSSOLA PORTA INSERTI CON SGANCIO RAPIDO 7/16"

Koken articolo	D mm	L mm	Box	Euro
13142-F11.2	22	46	1	44,99



NEW
POLLICI 7/16" ESAGONO



INSERTO CON MASCHIO ESAGONALE

Koken articolo	POLLICI	L mm	Box	Euro
183H-35-3/16	3/16"	35	1	7,34
183H-35-7/32	7/32"	35	1	7,34
183H-35-1/4	1/4"	35	1	7,34
183H-35-5/16	5/16"	35	1	7,84
183H-35-3/8	3/8"	35	1	7,84
183H-35-7/16	7/16"	35	1	7,84
183H-35-1/2	1/2"	35	1	13,15

TORX®

	S mm	S mm	
T 6	1.70	T 40	6.70
T 7	2.00	T 45	7.90
T 8	2.30	T 50	8.90
T 9	2.50	T 55	11.30
T 10	2.70	T 60	13.30
T 15	3.30	T 70	15.60
T 20	3.90	T 80	17.60
T 25	4.50	T 90	20.00
T 27	5.00	T 100	22.20
T 30	5.60		

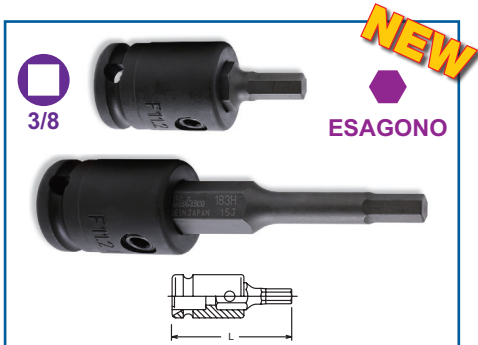

NEW

ESAGONO

**BUSSOLA MASCHIO ESAGONALE
IN DUE PARTI:**

BUSSOLA + INSERTO MASCHIO ESAGONALE

Koken articolo	mm	L mm		Euro
13134M-52-3	3	52	1	23,05
13134M-52-4	4	52	1	23,05
13134M-52-5	5	52	1	23,05
13134M-52-6	6	52	1	23,05
13134M-52-7	7	52	1	23,27
13134M-52-8	8	52	1	23,27
13134M-52-10	10	52	1	23,27
13134M-52-12	12	52	1	27,53
13134M-52-14	14	52	1	27,97
13134M-92-3	3	92	1	24,83
13134M-92-4	4	92	1	24,83
13134M-92-5	5	92	1	24,83
13134M-92-6	6	92	1	24,83
13134M-92-7	7	92	1	24,83
13134M-92-8	8	92	1	24,83
13134M-92-10	10	92	1	24,83
13134M-92-12	12	92	1	29,62
13134M-92-14	14	92	1	30,61

TORX®	S mm	S mm	
T 6	1.70	T 40	6.70
T 7	2.00	T 45	7.90
T 8	2.30	T 50	8.90
T 9	2.50	T 55	11.30
T 10	2.70	T 60	13.30
T 15	3.30	T 70	15.60
T 20	3.90	T 80	17.60
T 25	4.50	T 90	20.00
T 27	5.00	T 100	22.20
T 30	5.60		

**SOSTITUISCE
SERIE
107-11
KOKEN**

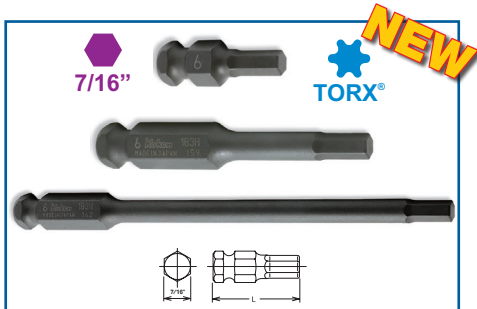

NEW

TORX®

INSERTO CON MASCHIO TORX®

Koken articolo		L mm		Euro
183T-35-T25	TX 25	35	1	8,58
183T-35-T30	TX 30	35	1	8,58
183T-35-T40	TX 40	35	1	8,58
183T-35-T45	TX 45	35	1	8,58
183T-35-T50	TX 50	35	1	8,80
183T-35-T55	TX 55	35	1	8,80
183T-35-T60	TX 60	35	1	14,27
183T-75-T30	TX 30	75	1	9,52
183T-75-T40	TX 40	75	1	9,52
183T-75-T45	TX 45	75	1	9,52
183T-75-T50	TX 50	75	1	9,52
183T-75-T55	TX 55	75	1	9,52
183T-75-T60	TX 60	75	1	16,36
183T-150-T30	TX 30	150	1	14,80
183T-150-T40	TX 40	150	1	14,80
183T-150-T45	TX 45	150	1	14,80
183T-150-T50	TX 50	150	1	14,80
183T-150-T55	TX 55	150	1	14,80

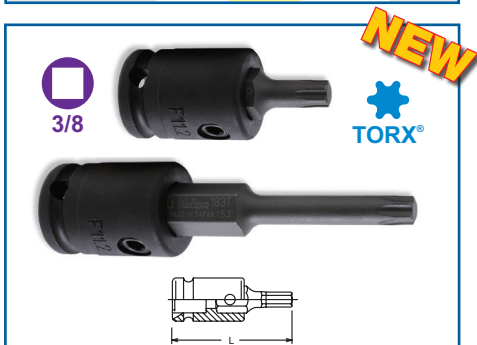

NEW

TORX®

BUSSOLA MASCHIO ESAGONALE

IN DUE PARTI:

BUSSOLA + INSERTO MASCHIO TORX®

Koken articolo		L mm		Euro
13134T-52-T30	TX 30	52	1	24,39
13134T-52-T40	TX 40	52	1	24,39
13134T-52-T45	TX 45	52	1	24,39
13134T-52-T50	TX 50	52	1	24,61
13134T-52-T55	TX 55	52	1	24,61
13134T-52-T60	TX 60	52	1	30,42
13134T-92-T30	TX 30	92	1	25,30
13134T-92-T40	TX 40	92	1	25,30
13134T-92-T45	TX 45	92	1	25,30
13134T-92-T50	TX 50	92	1	25,30
13134T-92-T55	TX 55	92	1	25,44
13134T-92-T60	TX 60	92	1	32,51

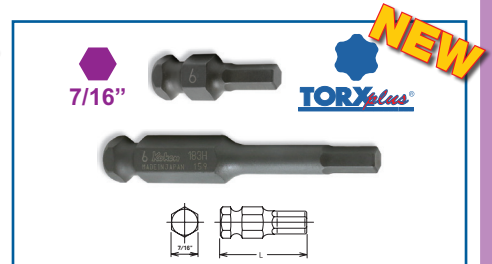

NEW

TORX Plus®

INSERTO CON MASCHIO TORX PLUS®

Koken articolo		L mm		Euro
183T-35-30IP	30IP	35	1	10,04
183T-35-40IP	40IP	35	1	10,04
183T-35-45IP	45IP	35	1	10,04
183T-35-50IP	50IP	35	1	10,45
183T-35-55IP	55IP	35	1	10,45
183T-35-60IP	60IP	35	1	17,60
183T-75-30IP	30IP	75	1	11,85
183T-75-40IP	40IP	75	1	11,85
183T-75-45IP	45IP	75	1	11,85
183T-75-50IP	50IP	75	1	11,85
183T-75-55IP	55IP	75	1	11,85
183T-75-60IP	60IP	75	1	20,10

	S mm	S mm	
8 IP	2.30	30 IP	5.60
9 IP	2.50	40 IP	6.70
10 IP	2.70	45 IP	7.90
15 IP	3.30	50 IP	8.90
20 IP	3.90	55 IP	11.30
25 IP	4.50	60 IP	13.30
27 IP	5.00		

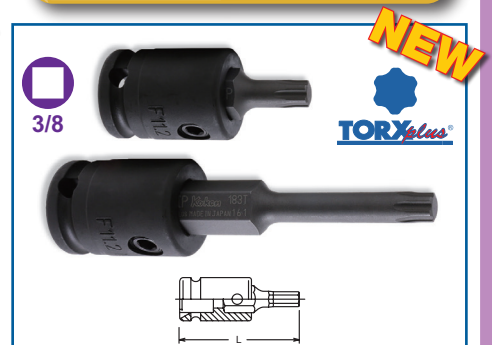

NEW

TORX Plus®

BUSSOLA MASCHIO ESAGONALE

IN DUE PARTI:

BUSSOLA + INSERTO MASCHIO TORX PLUS®

Koken articolo		L mm		Euro
13134T-52-30IP	30IP	52	1	25,91
13134T-52-40IP	40IP	52	1	25,91
13134T-52-45IP	45IP	52	1	25,91
13134T-52-50IP	50IP	52	1	26,35
13134T-52-55IP	55IP	52	1	26,35
13134T-52-60IP	60IP	52	1	33,28
13134T-92-30IP	30IP	92	1	27,69
13134T-92-40IP	40IP	92	1	27,69
13134T-92-45IP	45IP	92	1	27,69
13134T-92-50IP	50IP	92	1	27,69
13134T-92-55IP	55IP	92	1	27,69
13134T-92-60IP	60IP	92	1	35,75

IMPACT 3/8"



INSERTO CON MASCHIO XZN

Koken articolo	mm	L mm	Box	Euro
183X-35-M 4	M 4	35	1	8,83
183X-35-M 5	M 5	35	1	8,83
183X-35-M 6	M 6	35	1	8,83
183X-35-M 8	M 8	35	1	8,83
183X-35-M10	M10	35	1	9,35
183X-35-M12	M12	35	1	13,34
183X-35-M14	M14	35	1	14,27
183X-75-M 4	M 4	75	1	10,45
183X-75-M 5	M 5	75	1	10,45
183X-75-M 6	M 6	75	1	10,45
183X-75-M 8	M 8	75	1	10,45
183X-75-M10	M10	75	1	10,62
183X-75-M12	M12	75	1	15,79
183X-75-M14	M14	75	1	16,89
183X-150-M 5	M 5	150	1	17,19
183X-150-M 6	M 6	150	1	17,19
183X-150-M 8	M 8	150	1	21,42
183X-150-M10	M10	150	1	21,42
183X-150-M12	M12	150	1	26,07

XZN	S mm	S mm
M 4	3,60	M12 11,50
M 5	4,80	M14 13,30
M 6	6,10	M16 15,70
M 8	7,30	M18 16,90
M10	9,70	

**SOSTITUISCE
SERIE
107-11
KOKEN**

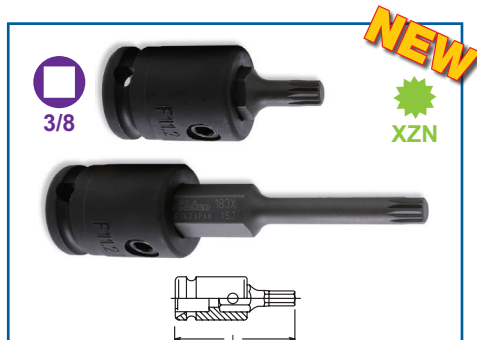

BUSSOLA MASCHIO ESAGONALE

IN DUE PARTI:

BUSSOLA + INSERTO MASCHIO XZN

Koken articolo	mm	L mm	Box	Euro
13134X-52-M5	M 5	52	1	24,97
13134X-52-M6	M 6	52	1	24,97
13134X-52-M8	M 8	52	1	24,97
13134X-52-M10	M10	52	1	25,49
13134X-52-M12	M12	52	1	29,48
13134X-52-M14	M14	52	1	30,42
13134X-92-M5	M 5	92	1	26,59
13134X-92-M6	M 6	92	1	26,59
13134X-92-M8	M 8	92	1	26,59
13134X-92-M10	M10	92	1	26,76
13134X-92-M12	M12	92	1	31,93
13134X-92-M14	M14	92	1	33,03

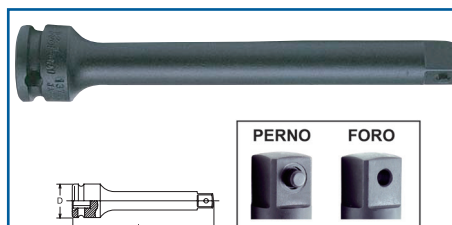

PROLUNGA

Koken articolo	D mm		L mm	Box	Euro
13760-50P	22	PERNO	50	1	17,88
13760-75P	22	PERNO	75	1	17,88
13760-100P	22	PERNO	100	1	19,33
13760-125P	22	PERNO	125	1	19,33
13760-150P	22	PERNO	150	1	22,22
13760-200P	22	PERNO	200	1	25,03
13760-250P	22	PERNO	250	1	25,03
NEW 13760-50	22	FORO	50	1	17,88
NEW 13760-75	22	FORO	75	1	17,88
NEW 13760-100	22	FORO	100	1	19,33
NEW 13760-125	22	FORO	125	1	19,33
NEW 13760-150	22	FORO	150	1	22,22
NEW 13760-200	22	FORO	200	1	25,03
NEW 13760-250	22	FORO	250	1	25,03

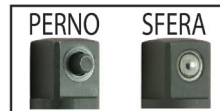
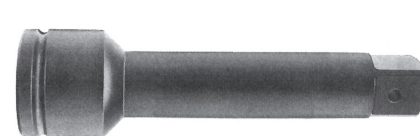

3/8"

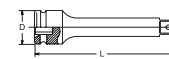

3/8"

PROLUNGHE PER BUSSOLE
"POWER IMPACT" MASCHIO/FEMMINA

articolo		L mm	Box	Euro
97-3	PERNO	75	1	12,60
97-3-100	PERNO	100	1	12,60
97-3-125	PERNO	125	1	13,65
97-4	PERNO	150	1	14,18
97-4-200	PERNO	200	1	17,85
97-5-250	PERNO	250	1	19,43
97-5-300	PERNO	300	1	24,15
97-3-125 SWF	SGANCIO RAPIDO	125	1	37,80
97-3 S	SFERA	75	1	12,60
97-3-100 S	SFERA	100	1	12,60
97-3-125 S	SFERA	125	1	13,65
97-4 S	SFERA	150	1	14,18
97-4-200 S	SFERA	200	1	17,85
97-5-250 S	SFERA	250	1	19,43

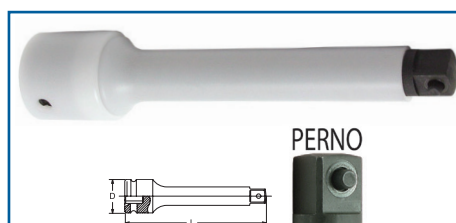

PROLUNGA CON RIVESTIMENTO

Koken articolo	D mm	L mm	Box	Euro
13760-125P.FR	26.2	125	1	119,60
13760-250P.FR	26.2	250	1	156,28



BGS

articolo

BGS 189

DESCRIZIONE

SNODO A MACCHINA

Euro

18,00

CARATTERISTICHE

- finitura nera
- con sfera di tenuta



NEW

BGS
articolo

DESCRIZIONE

Euro

BGS 9459	SET 3 PEZZI, SNODI	38,00
----------	--------------------	-------

CARATTERISTICHE

- con scanalatura e foro per spina
- comprende:
 - snodo 1/4" F - 1/4" M
 - snodo 3/8" F - 3/8" M
 - snodo 1/2" F - 1/2" M

1/4" 3/8" 1/2" PRO+ CROMO

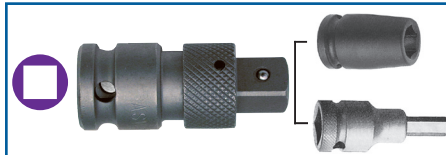

MANDRINO CON SGANCIO RAPIDO PER BUSSOLE "POWER IMPACT"

attacco: Quadro femmina
impronta: DIN 3126, E 11,2 - E 6,35

articolo	1/4"	3/8"	L mm	1	Euro
195-SWF	1/4"	1/4"	41	1	42,00
196-SWF	3/8"	3/8"	46	1	42,00
97-3-125 SWF	3/8"	3/8"	125	1	37,80
197-SWF	1/2"	1/2"	60	1	46,20
199-SWF	3/4"	3/4"	78	1	114,35
1991-SWF	1"	1"	100	1	131,25

Koken

articolo	1/4"	3/8"	L mm	1	Euro
12222 AL	1/4"	1/4"	35	1	50,44
13333 AL	3/8"	3/8"	45	1	53,05
14444 AL	1/2"	1/2"	55	1	58,27
16666 AL	3/4"	3/4"	75	1	121,94
18888 AL	1"	1"	95	1	178,01

NOTE

SNODO UNIVERSALE

articolo	PERNO	FORO	L mm	1	Euro
13771-P	PERNO		48	1	43,53
13771		FORO	48	1	43,53

DOPPIO SNODO

articolo	D mm	L mm	1	Euro
13772-P	22	75	1	66,47

SNODO UNIVERSALE

articolo	PERNO	FORO	L mm	1	Euro
13770-P	PERNO		56	1	41,39
13770		FORO	56	1	41,39



ESAGONO



CHIAVI A BUSSOLA
GUIDATE ANTI VIBRAZIONI
BOCCA ESAGONALE

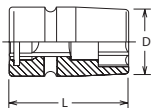

Koken articolo	mm	D mm	L mm	mm	Euro
NV13400M-8	8	13.3	43	1	30,97
NV13400M-10	10	15.8	43	1	30,97
NV13400M-11	11	17	43	1	30,97
NV13400M-12	12	18.3	43	1	30,97
NV13400M-13	13	19.5	43	1	33,72
NV13400M-14	14	20.8	43	1	33,72
NV13400M-15	15	22	43	1	33,72
NV13400M-16	16	23.3	43	1	33,72
NV13400M-17	17	24.5	43	1	33,72
NV13400M-18	18	25.8	43	1	36,74
NV13400M-19	19	27	43	1	36,74
NV13400M-21	21	29.5	43	1	38,12
NV13400M-22	22	30.8	43	1	38,25



ESAGONO



CHIAVI A BUSSOLA
GUIDATE ANTI
VIBRAZIONI
BOCCA ESAGONALE
EXTRA LUNGHE

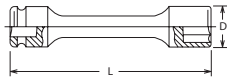

Koken articolo	mm	D mm	L mm	mm	Euro
NV13145M-100-6	6	13	100	1	43,97
NV13145M-100-8	8	13	100	1	43,97
NV13145M-100-10	10	15.5	100	1	43,97
NV13145M-100-12	12	18	100	1	43,97
NV13145M-100-13	13	19	100	1	44,88
NV13145M-100-14	14	21	100	1	44,88
NV13145M-100-15	15	22	100	1	44,88
NV13145M-100-16	16	24	100	1	44,88
NV13145M-100-17	17	25	100	1	44,88
NV13145M-150-6	6	13	150	1	70,04
NV13145M-150-8	8	13	150	1	70,04
NV13145M-150-10	10	15.5	150	1	70,04
NV13145M-150-12	12	18	150	1	70,04
NV13145M-150-13	13	19	150	1	71,64
NV13145M-150-14	14	21	150	1	71,64
NV13145M-150-15	15	22	150	1	71,64
NV13145M-150-16	16	24	150	1	71,64
NV13145M-150-17	17	25	150	1	71,64
NV13145M-200-6	6	13	200	1	71,20
NV13145M-200-8	8	13	200	1	71,20
NV13145M-200-10	10	15.5	200	1	71,20
NV13145M-200-12	12	18	200	1	71,20
NV13145M-200-13	13	19	200	1	72,57
NV13145M-200-14	14	21	200	1	72,57
NV13145M-200-15	15	22	200	1	72,57
NV13145M-200-16	16	24	200	1	72,57
NV13145M-200-17	17	25	200	1	72,57



PROLUNGA ANTI VIBRAZIONI

Koken articolo	D mm	L mm	mm	Euro
NV13760-75P	19	75	1	43,01
NV13760-125P	19	125	1	52,03
NV13760-150P	19	150	1	55,39
NV13760-250P	19	250	1	55,39



3/8



ELIMINAZIONE DELLE VIBRAZIONI
LA PROLUNGA DEL MANDRINO CALZA
SULLA PARETE CILINDRICA DELL' ALBERO
DELL' AVVITATORE
ATTENZIONE: CONTROLLARE LA
LUNGHEZZA DELL' ALBERO!

FE/MEC articolo	mm	L mm	mm	Euro	
NV 3814	3/8"	1/4" E	52	1	50,40
NV 38716	3/8"	7/16"	55	1	78,75



3/8



7/16"

BUSSOLA
PORTAINSERTI
ANTI
VIBRAZIONI
DA 7/16"

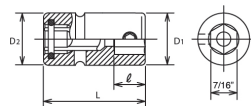

Koken articolo	D mm	L mm	mm	Euro
NV13134	22	45	1	87,78



3/8





3/8"

MANDRINI ANTIVIBRAZIONE PORTABUSSOLE
E SGANCIO RAPIDO

FE/MEC articolo	mm	L mm	mm	Euro	
NV196	3/8"	3/8"	75	1	51,45

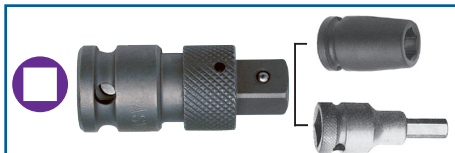
Guidate antivibrazioni



MANDRINO CON SGANCIO RAPIDO PER BUSSOLE "POWER IMPACT"

attacco: Quadro femmina
impronta: DIN 3126, E 11,2 - E 6,35

articolo	F	M	L mm	1	Euro
195-SWF	1/4"	1/4"	41	1	42,00
196-SWF	3/8"	3/8"	46	1	42,00
197-SWF	1/2"	1/2"	60	1	46,20
199-SWF	3/4"	3/4"	78	1	114,35
1991-SWF	1"	1"	100	1	131,25
Koken					
12222 AL	1/4"	1/4"	35	1	50,44
13333 AL	3/8"	3/8"	45	1	53,05
14444 AL	1/2"	1/2"	55	1	58,27
16666 AL	3/4"	3/4"	75	1	121,94
18888 AL	1"	1"	95	1	178,01

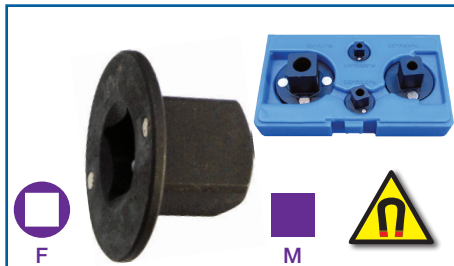

RACCORDI DI RIDUZIONE MAGNETICI "POWER IMPACT" A SCOMPARSA - SPAZI RIDOTTI

articolo	F	M	L mm	1	Euro
698-00	1/4"	3/8"	17	1	10,00
698-0	1/4"	1/2"	22	1	10,00
698-1	3/8"	1/2"	22	1	10,50
698-11	1/2"	3/4"	30	1	14,70
698-8	3/4"	1"	35	1	21,00
698-13	1"	1 1/2"	50	1	31,50
698-15	1 1/2"	2 1/2"	60	1	210,00
698	CASSETTA 4 PZ. CONTENUTO: 1 PZ. 698-00 1 PZ. 698-1 1 PZ. 698-11 1 PZ. 698-8			1	63,00

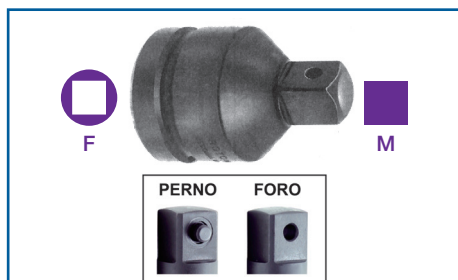

RACCORDI DI RIDUZIONE "POWER IMPACT" MASCHIO/FEMMINA

articolo	F	M	L mm	1	Euro
96-00	PERNO 1/4"	3/8"	32	1	12,47
96-0	PERNO 3/8"	1/4"	35	1	12,47
96-1	PERNO 3/8"	1/2"	45	1	12,47
96-01	PERNO 1/2"	1/4"	38	1	13,00
96-2	PERNO 1/2"	3/8"	45	1	13,56
96-3	FORO 5/8"	1/2"	50	1	20,07
96-4	PERNO 3/4"	1/2"	70	1	23,32
96-5	FORO 3/4"	5/8"	70	1	26,58
96-6	FORO 5/8"	3/4"	70	1	20,61
96-7	FORO 1/2"	5/8"	50	1	16,26
96-8	FORO 3/4"	1"	70	1	28,74
96-9	FORO 1"	3/4"	70	1	35,79
96-10	PERNO 1"	1/2"	70	1	65,00
96-11	FORO 1/2"	3/4"	50	1	17,89
96-12	FORO 1 1/2"	1"	115	1	121,80
96-13	FORO 1"	1 1/2"	115	1	51,51
96-14	FORO 2 1/2"	1 1/2"	115	1	379,60
96-15	FORO 1 1/2"	2 1/2"	120	1	260,30
96-16	FORO 1 1/4"	1"	140	1	126,00
96-17	FORO 1 3/4"	1 1/2"	150	1	294,00

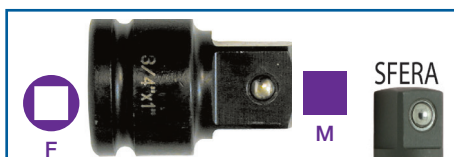

RACCORDI DI RIDUZIONE "POWER IMPACT" MASCHIO/FEMMINA CON SFERA DI TENUTA NEL QUADRO MASCHIO

articolo	F	M	L mm	1	Euro
696-00 S	1/4"	3/8"	26	1	10,00
696-0 S	3/8"	1/4"	32	1	10,00
696-01 S	1/2"	1/4"	36	1	10,00
696-1 S	3/8"	1/2"	36	1	10,00
696-2 S	1/2"	3/8"	38	1	10,50
696-11 S	1/2"	3/4"	48	1	12,60
696-4 S	3/4"	1/2"	56	1	16,80
696-8 S	3/4"	1"	63	1	22,05
696-9 S	1"	3/4"	75	1	28,35



articolo	DESCRIZIONE	Euro
BGS 200	SET 6 PEZZI RIDUZIONI A MACCHINA	46,92

CARATTERISTICHE

- rivestimento specifico nero opaco

CONTENUTO

- 1/4" F X 3/8" M, coppia massima 60 Nm
- 3/8" F X 1/4" M, coppia massima 60 Nm
- 3/8" F X 1/2" M, coppia massima 200 Nm
- 1/2" F X 3/8" M, coppia massima 200 Nm
- 1/2" F X 3/4" M, coppia massima 500 Nm
- 3/4" F X 1/2" M, coppia massima 500 Nm

RICAMBI

articolo	DESCRIZIONE	Euro
BGS 200-LEER	CASSETTA VUOTA	5,46



articolo	DESCRIZIONE	Euro
BGS 25140	SET 11 PEZZI RIDUZIONI E SNODI A MACCHINA	113,48

CARATTERISTICHE

- rivestimento specifico nero opaco

CONTENUTO

- 1/4" F x 3/8" M
- 3/8" F x 1/4" M
- 3/8" F x 1/2" M
- 1/2" F x 3/8" M
- 1/2" F x 3/4" M
- 3/4" F x 1/2" M
- 3/4" F x 1" M
- 1" F x 3/4" M
- snodi da 1/4", 3/8", 1/2"



3/8



1/2"

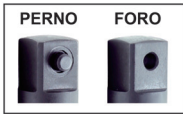

RACCORDO DI RIDUZIONE QUADRO MASCHIO 1/2" E FEMMINA 3/8"

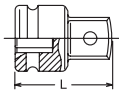

Kokken articolo		L mm		Euro
13344A-P	PERNO	32,5	1	17,77
13344A	FORO	32,5	1	17,77

3/8



1/4"

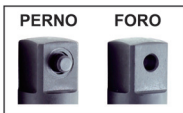

RACCORDO DI RIDUZIONE QUADRO MASCHIO 1/4" E FEMMINA 3/8"

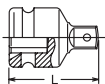

Kokken articolo		L mm		Euro
13322A-P	PERNO	25	1	16,75
13322A	FORO	25	1	16,75

F

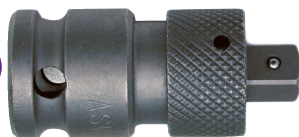

M

RACCORDI DI RIDUZIONE A MANDRINO CON SGANCIO RAPIDO "POWER IMPACT"

articolo	F	M	L mm		Euro
691-0 SWF	3/8"	1/4"	55	1	31,50
691-1 SWF	3/8"	1/2"	60	1	31,50
691-2 SWF	1/2"	3/8"	55	1	36,75
691-11 SWF	1/2"	3/4"	75	1	42,00
691-4 SWF	3/4"	1/2"	70	1	42,00
691-9 SWF	1"	3/4"	90	1	73,50



SPINE ACCIAIO PER BUSSOLE

Kokken articolo		L mm		Euro
1200 A	1/4"	10,2	1	0,44
1301 A	3/8"	14,5	1	0,44
1302 A	3/8"	17,5	1	0,44
1401 A	1/2"	20	1	0,74
1402 A	1/2"	25	1	0,74
1500 A	5/8"	30	1	0,74
1601 A	3/4"	35	1	0,83
1602 A	3/4"	45	1	0,94
1801 A	1"	45	1	0,94
1802 A	1"	75	1	1,82
1701 A	1 1/2"	75	1	1,98
1702 A	1 1/2"	110	1	3,99
1901 A	2 1/2"	110	1	4,46
1902 A	2 1/2"	155	1	5,06
2001 A	3 1/2"	155	1	8,36
2002 A	3 1/2"	180	1	6,90

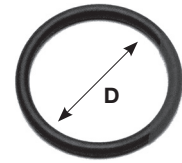

ANELLI DI GOMMA PER BUSSOLE

Kokken articolo		D mm		Euro
1200 B	1/4"	9	1	0,72
1301 B	3/8"	13	1	0,83
1302 B	3/8"	16	1	0,88
1401 B	1/2"	19	1	1,02
1402 B	1/2"	24	1	1,10
1500 B	5/8"	28	1	1,35
1601 B	3/4"	36	1	1,46
1602 B	3/4"	45	1	2,15
1801 B	1"	45	1	1,98
1802 B	1"	75	1	8,72
1701 B	1 1/2"	75	1	8,58
1702 B	1 1/2"	114	1	21,42
1901 B	2 1/2"	114	1	22,25
1902 B	2 1/2"	158	1	27,72
2001 B	3 1/2"	158	1	82,80
2002 B	3 1/2"	183	1	91,88



ESTRATTORE PER MOLLE DI SICUREZZA

Kokken articolo				Euro
149	3/8" - 1/2"	1		1,57
152	3/4" - 1"	1		1,68

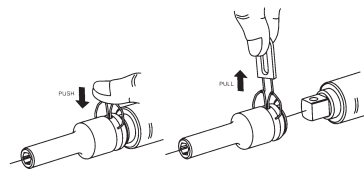

MOLLA DI SICUREZZA PER BUSSOLE

Kokken articolo		Ø		Euro
1301C	3/8"	≤12	1	0,94
1302C	3/8"	>12	1	0,94
1401C	1/2"	≤14	1	1,18
1402C	1/2"	>14	1	1,18
1600C	3/4"	≤46	1	2,26
1801C	1"	≤70	1	2,23
1802C	1"	>70	1	7,87
1700C	1 1/2"	≤90	1	8,22

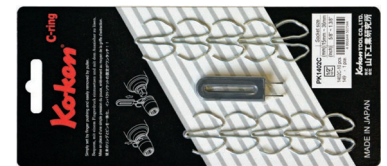

SET MOLLE DI SICUREZZA PER BUSSOLE

Kokken articolo	nr.			Euro
PK1301 C-10	10	149	1	13,92
PK1302 C-10	10	149	1	13,92
PK1401 C-10	10	149	1	16,86
PK1402 C-10	10	149	1	16,86
PK1600 C-10	10	149	1	25,82
PK1801 C-10	10	149	1	26,32

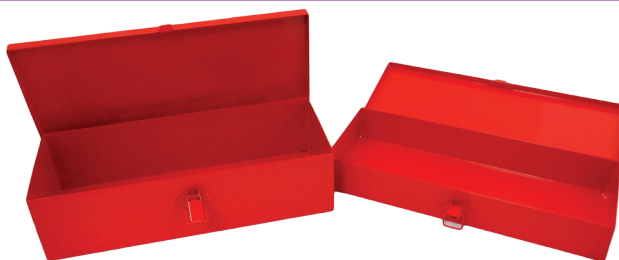

CASSETTE METALLICHE PORTA-BUSSOLE

FERMEC articolo	Dimensioni (lunghezza x larghezza x altezza) mm		Euro
CASS-2510	280 x 100 x 40 mm	1	26,25
CASS-3112	310 x 120 x 80 mm	1	39,90
CASS-3211	320 x 115 x 50 mm	1	42,00
CASS-6213	610 x 130 x 85 mm	1	55,00

NOTE

- a richiesta assortimento di bussole a macchina in cassetta metallica

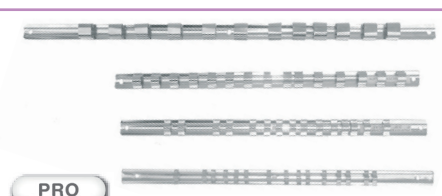

PRO

GUIDE PORTA BUSSOLE CON CLIP

BG articolo	Numero Clip	Euro
BGS 2316 1/4"	7	2,93
BGS 2317 3/8"	7	3,19
BGS 2318 1/2"	7	3,32
BGS 2120 1/4"	15	4,08
BGS 2330 3/8"	15	4,59
BGS 2540 1/2"	15	4,46
BGS 3460 3/4"	12	8,93

CARATTERISTICHE

- cromato satinato



GUIDE PORTA BUSSOLE PER MOLLE IN ACCIAIO DA 1/4" - 3/8" - 1/2" - 3/4"

Kokon articolo	L mm		Euro
R 158	158	1	2,52
R 251	251	1	2,56
R 300	300	1	2,62
R 400	400	1	2,71

MOLLE IN ACCIAIO PER GUIDE

Kokon articolo	Numero Clip		Euro
C 14 1/4"	1	1	0,34
C 38 3/8"	1	1	0,34
C 12 1/2"	1	1	0,34
C 34 3/4"	1	1	0,50

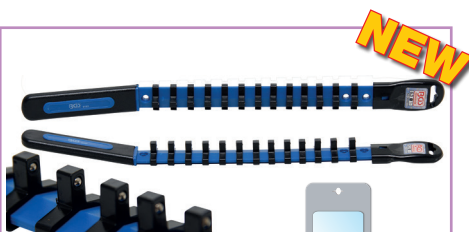

GUIDE PORTA BUSSOLE CON CLIP

BG articolo	Numero Clip	Euro
BGS 9193 1/4"	13	3,83
BGS 9194 3/8"	11	4,08
BGS 9195 1/2"	9	4,34

CARATTERISTICHE

- clip con sfere di tenuta



GUIDE MAGNETICHE PORTA BUSSOLE CON CLIP

BG articolo	Numero Clip	L mm	Euro
BGS 9342 1/4"	12	310	22,19
BGS 9343 3/8"	12	310	22,44
BGS 9344 1/2"	12	310	22,70

CARATTERISTICHE

- clip con sfera per bussole realizzate in plastica rinforzata
- magneti rivestiti in gomma protettiva



GUIDE MAGNETICHE PORTA BUSSOLE CON CLIP



Kokon articolo	Nr. Clip	L mm		Euro
RSAL200-1/4x12 1/4"	12	200	1	37,68
RSAL200-3/8x8 3/8"	8	200	1	35,56
RSAL300-3/8x12 3/8"	12	300	1	42,90
RSAL300-1/2x10 1/2"	10	300	1	44,85





GUIDE PORTA BUSSOLE MAGNETICHE PER MOLLE IN PLASTICA



Kokon articolo	L mm		Euro
RSAL-200 200	200	1	31,54
RSAL-300 300	300	1	36,63

MOLLE IN PLASTICA PER GUIDE

Koken articolo			Euro
CLIP-1/4	1/4"	1	0,55
CLIP-3/8	3/8"	1	0,55
CLIP-1/2	1/2"	1	0,55

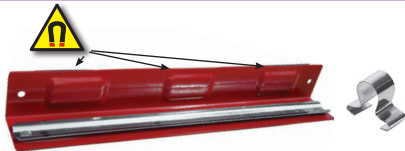

**GUIDA MAGNETICA PER MOLLE PORTA
BUSSOLE DA 1/4" - 3/8" - 1/2" - 3/4"**

FERMEC articolo	L mm		Euro
MAG300	300	1	20,50



PRO+

BARRA PORTABUSSOLE MAGNETICA,

BGS articolo		Numero vani	Euro
BGS 3011-1	1/4"	10	5,36
BGS 3011-2	3/8"	12	8,16
BGS 3011-3	1/2"	10	11,09

CARATTERISTICHE

- le bussole sono trattenute grazie ad una banda magnetica



1/4" 3/8" 1/2" 3/4" 1"

CLIP X ATTACCO QUADRO FEMMINA

BGS articolo		Euro
BGS HANGER-1	1/4"	1,91
BGS HANGER-2	3/8"	1,91
BGS HANGER-3	1/2"	1,91
BGS HANGER-4	3/4"	2,04
BGS HANGER-5	1"	2,04

CARATTERISTICHE

- clip in plastica con quadro maschio
- ad esempio per esposizione bussole

NOTE



ESAGONO

CHIAVI A BUSSOLA A
MANO BOCCA ESAGONALE

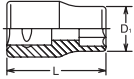

Koken articolo	mm	D ₁ mm	L mm		Euro
4401M-8	8	13.2	36	1	5,80
4401M-9	9	13.8	37	1	5,80
4401M-10	10	15.3	37	1	5,80
4401M-11	11	16.5	37	1	5,80
4401M-12	12	17.8	37	1	5,80
4401M-13	13	19	37	1	5,80
4401M-14	14	20.3	37	1	6,27
4401M-15	15	21.5	37	1	6,27
4401M-16	16	22.8	37	1	6,27
4401M-17	17	24	37	1	6,27
4401M-18	18	25	37	1	6,33
4401M-19	19	26.5	38	1	6,33
4401M-20	20	27.8	38	1	7,21
4401M-21	21	29	38	1	7,21
4401M-22	22	30	40	1	7,21
4401M-23	23	31.5	40	1	7,67
4401M-24	24	32.8	42	1	7,73
4401M-25	25	34	42	1	9,68
4401M-26	26	35	42	1	9,68
4401M-27	27	36.5	43	1	9,68
4401M-28	28	37.8	43	1	11,44
4401M-29	29	39	43	1	11,55
4401M-30	30	40	46	1	12,43
4401M-31	31	41.5	46	1	12,43
4401M-32	32	42.8	46	1	12,43
4400M-33	33	44.2	47	1	18,56
4400M-34	34	45.2	47	1	18,87
4400M-35	35	46.2	47	1	19,61
4400M-36	36	47.2	47	1	19,86
4400M-37	37	48.3	47	1	26,13
4400M-38	38	49.2	47	1	26,13
4400M-41	41	53.1	47	1	47,77
4400M-46	46	59.1	47	1	47,77



POLIGONALE

CHIAVI A BUSSOLA A
MANO BOCCA POLIGONALE

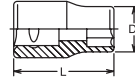

Koken articolo	mm	D ₁ mm	L mm		Euro
4406M-8	8	13.2	36	1	5,80
4406M-9	9	13.8	37	1	5,80
4406M-10	10	15.3	37	1	5,80
4406M-11	11	16.5	37	1	5,80
4406M-12	12	17.8	37	1	5,80
4406M-13	13	19	37	1	5,80
4406M-14	14	20.3	37	1	6,27
4406M-15	15	21.5	37	1	6,27
4406M-16	16	22.8	37	1	6,27
4406M-17	17	24	37	1	6,27
4406M-18	18	25	37	1	6,33
4406M-19	19	26.5	38	1	6,33
4406M-20	20	27.8	38	1	7,21
4406M-21	21	29	38	1	7,21
4406M-22	22	30	40	1	7,21
4406M-23	23	31.5	40	1	7,67
4406M-24	24	32.8	42	1	8,00
4406M-25	25	34	42	1	9,68
4406M-26	26	35	42	1	9,68
4406M-27	27	36.5	43	1	9,68
4406M-28	28	37.8	43	1	11,44
4406M-29	29	39	43	1	11,55
4406M-30	30	40	46	1	12,43
4406M-31	31	41.5	46	1	12,43
4406M-32	32	42.8	46	1	12,43
4405M-33	33	44.2	47	1	18,56
4405M-34	34	45.2	47	1	18,87
4405M-35	35	46.2	47	1	19,61
4405M-36	36	47.2	47	1	19,86
4405M-37	37	48.3	47	1	26,13
4405M-38	38	49.2	47	1	26,13
4405M-41	41	53.1	47	1	47,77
4405M-46	46	59.1	47	1	47,77

POLLICI



ESAGONO

CHIAVI A BUSSOLA A
MANO BOCCA ESAGONALE

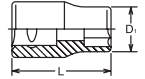

Koken articolo	pollici	D ₁ mm	L mm		Euro
NEW 4400A-1/4	1/4"	10.7	36	1	6,16
4400A-5/16	5/16"	13.2	36	1	6,27
4400A-3/8	3/8"	14.6	37	1	6,27
4400A-7/16	7/16"	16.5	37	1	6,27
4400A-1/2	1/2"	19	37	1	6,27
4400A-9/16	9/16"	20.3	37	1	6,77
4400A-19/32	19/32"	21.5	37	1	6,77
4400A-5/8	5/8"	22.8	37	1	6,77
4400A-21/32	21/32"	24	37	1	6,77
4400A-11/16	11/16"	25	37	1	6,82
4400A-3/4	3/4"	26.5	38	1	6,82
4400A-25/32	25/32"	27.8	38	1	7,73
4400A-13/16	13/16"	29	38	1	7,73
4400A-7/8	7/8"	30	40	1	7,73
4400A-15/16	15/16"	32.8	42	1	8,33
4400A-31/32	31/32"	34	42	1	10,40
4400A-1	1"	35	42	1	10,40
4400A-1-1/16	1-1/16"	36.5	43	1	10,40
4400A-1-1/8	1-1/8"	39	43	1	12,43
4400A-1-3/16	1-3/16"	40	46	1	13,42
4400A-1-1/4	1-1/4"	42.8	46	1	13,42
4400A-1-5/16	1-5/16"	44.2	47	1	19,99
4400A-1-3/8	1-3/8"	46.2	47	1	21,12
4400A-1-7/16	1-7/16"	47.2	47	1	28,16
4400A-1-1/2	1-1/2"	49.2	47	1	28,16



NEW



ESAGONO

FENEC
articolo

DESCRIZIONE

Euro

FM 31032

**SET 6 PEZZI, INSERTI
ANTI-GRAFFIO PER
CHIAVI A BUSSOLA
ESAGONALI**

8,00

CARATTERISTICHE



- inserti speciali che, utilizzati all'interno delle bussole esagonali tradizionali, consentono di prevenire danni a parti cromate o verniciate o, più in generale, con trattamenti superficiali
- comprende:
 - inserto 8 mm, per bussola 12 mm, coppia 9 Nm
 - inserto 10 mm, per bussola 14 mm, coppia 17 Nm
 - inserto 12 mm, per bussola 16 mm, coppia 27 Nm
 - inserto 13 mm, per bussola 17 mm, coppia 45 Nm
 - inserto 15 mm, per bussola 19 mm, coppia 50 Nm
 - inserto 17 mm, per bussola 22 mm, coppia 79 Nm
- per uso con bussole esagonali metriche



KOKEN 1/2"

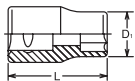

POLLICI

POLIGONALE
**CHIAVI A BUSSOLA A
MANO BOCCA POLIGONALE**

Koken articolo	 pollici	D ₁ mm	L mm		Euro
4405A-1/4	1/4"	13.2	36	1	6,16
4405A-5/16	5/16"	13.2	36	1	6,27
4405A-3/8	3/8"	14.6	37	1	6,27
4405A-7/16	7/16"	16.5	37	1	6,27
4405A-1/2	1/2"	19	37	1	6,27
4405A-9/16	9/16"	20.3	37	1	6,77
4405A-19/32	19/32"	21.5	37	1	6,77
4405A-5/8	5/8"	22.8	37	1	6,77
4405A-21/32	21/32"	24	37	1	6,77
4405A-11/16	11/16"	25	37	1	6,82
4405A-3/4	3/4"	26.5	38	1	6,82
4405A-25/32	25/32"	27.8	38	1	7,73
4405A-13/16	13/16"	29	38	1	7,73
4405A-7/8	7/8"	30	40	1	7,73
4405A-15/16	15/16"	32.8	42	1	8,33
4405A-31/32	31/32"	34	42	1	10,40
4405A-1	1"	35	42	1	10,40
4405A-1-1/16	1-1/16"	36.5	43	1	10,40
4405A-1-1/8	1-1/8"	39	43	1	12,43
4405A-1-3/16	1-3/16"	40	46	1	13,42
4405A-1-1/4	1-1/4"	42.8	46	1	13,42
4405A-1-5/16	1-5/16"	44.2	47	1	19,99
4405A-1-3/8	1-3/8"	46.2	47	1	21,12
4405A-1-7/16	1-7/16"	47.2	47	1	28,16
4405A-1-1/2	1-1/2"	49.2	47	1	28,16

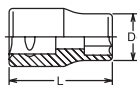

**SURFACE
DRIVE**
**CHIAVI A BUSSOLA A
MANO BOCCA
SURFACE DRIVE**



Koken articolo	 mm	D ₁ mm	L mm		Euro
4410M-8	8	13.2	36	1	6,11
4410M-9	9	13.8	37	1	6,11
4410M-10	10	15.3	37	1	6,11
4410M-11	11	16.5	37	1	6,11
4410M-12	12	17.8	37	1	6,11
4410M-13	13	19	37	1	6,11
4410M-14	14	20.3	37	1	6,57
4410M-15	15	21.5	37	1	6,57
4410M-16	16	22.8	37	1	6,57
4410M-17	17	24	37	1	6,57
4410M-18	18	25	37	1	6,63
4410M-19	19	26.5	38	1	6,63
4410M-20	20	27.8	38	1	7,54
4410M-21	21	29	38	1	7,54
4410M-22	22	30	40	1	7,54
4410M-23	23	31.5	40	1	8,11
4410M-24	24	32.8	42	1	8,11
4410M-25	25	34	42	1	10,15
4410M-26	26	35	42	1	10,15
4410M-27	27	36.5	43	1	10,15
4410M-28	28	37.8	43	1	12,02
4410M-29	29	39	43	1	12,13
4410M-30	30	40	46	1	13,06
4410M-31	31	41.5	46	1	13,06
4410M-32	32	42.8	46	1	13,06
4410M-34	34	45.2	47	1	19,80

Koken

NEW

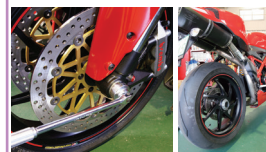
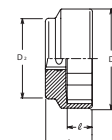

 1/2"

POLIGONALE

**CHIAVI A BUSSOLA A
MANO BOCCA POLIGONALE
EXTRA CORTE PER DADO
ASSE POSTERIORE MOTO**

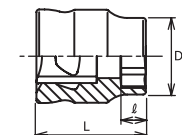
Koken articolo	 mm	D ₁ mm	L mm		Euro
4405M-DU-36	36	47.3	28	1	59,46
4405M-DU-55	55	71	31	1	75,87



ESAGONO



NEW
**CHIAVI A BUSSOLA
BOCCA ESAGONALE
EXTRA CORTE**

Koken articolo	 mm	D ₁ mm	L mm		Euro
4400MZ-8	8	12.6	26	1	8,17
4400MZ-10	10	15	26	1	8,17
4400MZ-12	12	17.5	27	1	8,17
4400MZ-13	13	18.7	28	1	8,17
4400MZ-14	14	19.8	28	1	8,31
4400MZ-16	16	22.3	28	1	8,64
4400MZ-17	17	23.6	29	1	8,64
4400MZ-18	18	24.8	29	1	9,30
4400MZ-19	19	26	29	1	9,30
4400MZ-21	21	28.4	29	1	12,84
4400MZ-22	22	29.6	29	1	12,84
4400MZ-24	24	32	29	1	14,80
4400MZ-27	27	35.7	30	1	16,47
4400MZ-30	30	39.3	31	1	17,55
4400MZ-32	32	41.7	32	1	18,98

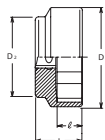

 1/2"
 
ESAGONO

**CHIAVI A BUSSOLA A
MANO BOCCA ESAGONALE
EXTRA CORTE PER DADO
CENTRALE CATENA-RUOTA**

Koken articolo	 mm	D ₁ mm	L mm		Euro
4400M-DU-41	41	53	28	1	69,80
4400M-DU-46	46	59	28	1	73,62





OTTAGONALE OTTO ANGOLI

CHIAVI A BUSSOLA A MANO BOCCA OTTAGONALE

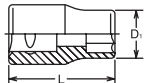

Koken articolo	mm	D ₁ mm	L mm		Euro
4109M-14	14	26	38	1	9,68
4109M-17	17	28	40	1	9,68
4109M-19	19	29	40	1	11,28
4109M-21.5	21.5	32	40	1	11,55
4109M-23	23	34	43	1	14,69



TORXplus

CHIAVI A BUSSOLA BOCCA TORX PLUS®

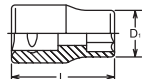

Koken articolo		D ₁	L mm		Euro
4425-10EPL	10EPL	13.2	36	1	15,59
4425-12EPL	12EPL	14.6	37	1	15,59
4425-14EPL	14EPL	16.5	37	1	15,59
4425-16EPL	16EPL	19.0	37	1	15,59
4425-18EPL	18EPL	20.3	37	1	15,59
4425-20EPL	20EPL	22.9	37	1	16,47



NUT GRIP® BLOCCADADI

CHIAVI A BUSSOLA A MANO BOCCA NUT GRIP®

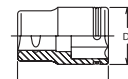

Koken articolo	mm	D ₁ mm	L mm		Euro
4450M-10	10	15.3	36	1	9,82
4450M-11	11	16.5	36	1	9,82
4450M-12	12	17.8	36	1	9,82
4450M-13	13	19	36	1	10,15
4450M-14	14	20.3	36	1	10,15
4450M-15	15	21.5	36	1	10,20
4450M-16	16	22.8	36	1	10,20
4450M-17	17	24	36	1	10,20
4450M-18	18	25	36	1	10,29
4450M-19	19	26.5	36	1	10,29
4450M-21	21	29	37	1	10,86
4450M-22	22	30	37	1	10,86
4450M-24	24	32.8	39	1	11,85
4450M-27	27	36.5	40	1	13,64



TORX®

CHIAVI A BUSSOLA A MANO BOCCA TORX®

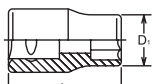

Koken articolo		D ₁ mm	L mm		Euro
4425-E8	E 8	10.7	36	1	6,57
4425-E10	E10	13.2	36	1	6,49
4425-E11	E11	13.8	37	1	6,49
4425-E12	E12	14.6	37	1	6,49
4425-E14	E14	16.5	37	1	6,49
4425-E16	E16	19	37	1	6,49
4425-E18	E18	20.3	37	1	6,49
4425-E20	E20	22.8	37	1	7,21
4425-E22	E22	25	37	1	9,16
4425-E24	E24	26.5	40	1	10,56

TORX PLUS®

	S mm	S mm	
E 4	3.70	E 16	14.60
E 5	4.60	E 18	16.50
E 6	5.60	E 20	18.30
E 7	6.10	E 22	20.10
E 8	7.40	E 24	22.00
E 10	9.30	E 26	23.70
E 11	9.90	E 28	25.50
E 12	11.00	E 30	27.30
E 14	12.80	E 32	29.00



SYSTEM 6

CHIAVI A BUSSOLA A MANO BOCCA SYSTEM 6

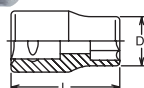

Koken articolo		D mm	L mm		Euro
4400LH-6S	6S	17.3	36	1	9,24
4400LH-8S	8S	17.3	37	1	9,24
4400LH-10S	10S	17.3	37	1	9,24
4400LH-12S	12S	17.3	37	1	9,79
4400LH-14S	14S	17.3	37	1	10,51
4400LH-16S	16S	17	38	1	12,05

TORX®

	S mm	S mm	
E 4	3.70	E 16	14.60
E 5	4.60	E 18	16.50
E 6	5.60	E 20	18.30
E 7	6.10	E 22	20.10
E 8	7.40	E 24	22.00
E 10	9.30	E 26	23.70
E 11	9.90	E 28	25.50
E 12	11.00	E 30	27.30
E 14	12.80	E 32	29.00



LHSTIX®

	d mm	D mm
LH 3 S	3.80	4.70
LH 4 S	4.50	6.00
LH 5 S	5.60	7.50
LH 6 S	6.80	9.00
LH 7 S	7.90	10.50
LH 8 S	9.00	12.00
LH 10 S	11.30	15.00
LH 12 S	13.60	18.00
LH 14 S	15.80	21.00
LH 16 S	18.10	24.00

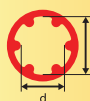

SERIE 10 PZ. CHIAVI A BUSSOLA MISURE: 10, 11, 12, 13, 14, 15, 16, 17, 18, 19 MM

Koken articolo			Euro
RS4401M/10		1	58,74
RS4406M/10		1	58,74
RS4410M/10		1	62,04

POLLICI



SERIE 10 PZ. CHIAVI A BUSSOLA BOCCA ESAGONALE MISURE: 3/8", 7/16", 1/2", 9/16", 5/8", 11/16", 3/4", 13/16", 7/8", 15/16"

Koken articolo			Euro
RS4400A/10		1	67,40
RS4405A/10		1	67,40

SERIE 7 PZ. CHIAVI A BUSSOLA BOCCA TORX®

Koken articolo	TORX®	1	Euro
RS4425/7	E10, E12, E14, E16, E18, E20, E24	1	48,92

SERIE 14 PZ. CHIAVI A BUSSOLA BOCCA TORX®

Koken articolo	TORX®	1	Euro
RSX425/14	SERIE 14 PZ.	1	73,98

CARATTERISTICHE

1/4"	E4, E5, E6, E7, E8
3/8"	E10, E11, E12, E14
1/2"	E16, E18, E20, E22, E24

SYSTEM 6 RIBE
SERIE 6 PZ. CHIAVI A BUSSOLA BOCCA SYSTEM 6

Koken articolo	SYSTEM 6 RIBE	1	Euro
RS4400LH/6	6S, 8S, 10S, 12S, 14S, 16S	1	56,54

SERIE 6 PZ. CHIAVI A BUSSOLA BOCCA TORX PLUS®

Koken articolo	TORX PLUS®	1	Euro
RS4425/6-EPL	10EPL, 12EPL, 14EPL, 16EPL, 18EPL, 20EPL	1	90,81

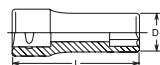
CHIAVI A BUSSOLA A MANO BOCCA ESAGONALE LUNGHE

Koken articolo	mm	D ₁ mm	L mm	1	Euro
4300M-8	8	13.2	77	1	12,73
4300M-9	9	13.8	77	1	12,73
4300M-10	10	15.3	77	1	12,73
4300M-11	11	16.5	77	1	12,73
4300M-12	12	17.8	77	1	12,73
4300M-13	13	19	77	1	12,73
4300M-14	14	20.3	77	1	12,73
4300M-15	15	21.5	77	1	12,95
4300M-16	16	22.8	77	1	13,26
4300M-17	17	24	77	1	13,26
4300M-18	18	25	77	1	13,92
4300M-19	19	26.5	77	1	13,92
4300M-20	20	27.8	77	1	15,15
4300M-21	21	29	77	1	16,31
4300M-22	22	30	77	1	16,31
4300M-23	23	31.5	77	1	17,55
4300M-24	24	32.8	77	1	18,48
4300M-25	25	34	77	1	19,80
4300M-26	26	35	77	1	19,80
4300M-27	27	36.5	77	1	19,80
4300M-28	28	37.8	77	1	22,99
4300M-29	29	39	77	1	24,09
4300M-30	30	40	77	1	24,09
4300M-31	31	41.5	77	1	24,09
4300M-32	32	42.8	77	1	24,09
4300M-33	33	44.2	77	1	40,78
4300M-34	34	45.2	77	1	42,19
4300M-35	35	46.2	77	1	42,19
4300M-36	36	47.2	77	1	43,01
4300M-37	37	48.2	77	1	44,19
4300M-38	38	49	77	1	47,55

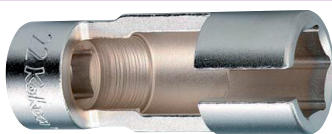
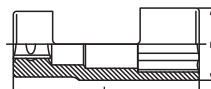
CHIAVI A BUSSOLA A MANO BOCCA ESAGONALE PER SONDE LAMBDA

Koken articolo	mm	D mm	L mm	1	Euro
SP4300M-85	22	33	85	1	46,20
SP4300M-110	22	33	110	1	52,72

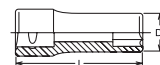
CHIAVI A BUSSOLA A MANO BOCCA POLIGONALE LUNGHE

Koken articolo	mm	D ₁ mm	L mm	1	Euro
4305M-8	8	13.2	77	1	12,73
4305M-9	9	13.8	77	1	12,73
4305M-10	10	15.3	77	1	12,73
4305M-11	11	16.5	77	1	12,73
4305M-12	12	17.8	77	1	12,73
4305M-13	13	19	77	1	12,73
4305M-14	14	20.3	77	1	12,73
4305M-15	15	21.5	77	1	12,95
4305M-16	16	22.8	77	1	13,26
4305M-17	17	24	77	1	13,26
4305M-18	18	25	77	1	13,92
4305M-19	19	26.5	77	1	13,92
4305M-20	20	27.8	77	1	15,15
4305M-21	21	29	77	1	16,31
4305M-22	22	30	77	1	16,31
4305M-23	23	31.5	77	1	17,55
4305M-24	24	32.8	77	1	18,48
4305M-25	25	34	77	1	19,80
4305M-26	26	35	77	1	19,80
4305M-27	27	36.5	77	1	19,80
4305M-28	28	37.8	77	1	22,99
4305M-29	29	39	77	1	24,09
4305M-30	30	40	77	1	24,09
4305M-31	31	41.5	77	1	24,09
4305M-32	32	42.8	77	1	24,09
4305M-33	33	44.2	77	1	40,78
4305M-34	34	45.2	77	1	42,19
4305M-35	35	46.2	77	1	42,19
4305M-36	36	47.2	77	1	43,01
4305M-37	37	48.2	77	1	44,19
4305M-38	38	49	77	1	47,55

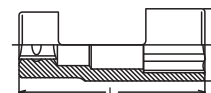

1/2"

CHIAVI A BUSSOLA A MANO BOCCA POLIGONALE PER INIETTORI MOTORI DIESEL

Koken articolo	mm	D mm	L mm	1	Euro
SP4305M-77	27	36,5	77	1	32,45



POLLICI



CHIAVI A BUSSOLA A MANO BOCCA ESAGONALE LUNGHE

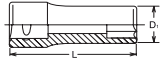

Koken articolo	pollici	D ₁ mm	L mm		€uro
4300A-5/16	5/16"	13.2	77	1	13,72
4300A-3/8	3/8"	14.6	77	1	13,72
4300A-7/16	7/16"	16.5	77	1	13,72
4300A-1/2	1/2"	19	77	1	13,72
4300A-9/16	9/16"	20.3	77	1	13,72
4300A-19/32	19/32"	21.5	77	1	14,00
4300A-5/8	5/8"	22.8	77	1	14,27
4300A-21/32	21/32"	24	77	1	14,27
4300A-11/16	11/16"	25	77	1	15,02
4300A-3/4	3/4"	26.5	77	1	15,02
4300A-25/32	25/32"	27.8	77	1	16,31
4300A-13/16	13/16"	29	77	1	17,57
4300A-7/8	7/8"	30	77	1	17,57
4300A-15/16	15/16"	32.8	77	1	19,91
4300A-31/32	31/32"	34	77	1	21,29
4300A-1	1"	34	77	1	21,29
4300A-1-1/16	1-1/16"	36.5	77	1	21,29
4300A-1-1/8	1-1/8"	37.8	77	1	25,93
4300A-1-3/16	1-3/16"	40	77	1	25,93
4300A-1-1/4	1-1/4"	42.8	77	1	25,93
4300A-1-5/16	1-5/16"	44.2	77	1	43,97
4300A-1-3/8	1-3/8"	46.2	77	1	45,46
4300A-1-7/16	1-7/16"	48	77	1	47,69
4300A-1-1/2	1-1/2"	49	77	1	51,26
4300A-1-13/16	1-13/16"	59	77	1	69,03

POLLICI



CHIAVI A BUSSOLA A MANO BOCCA POLIGONALE LUNGHE

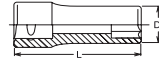

Koken articolo	mm	D ₁ mm	L mm		€uro
4305A-5/16	5/16"	13.2	77	1	13,72
4305A-3/8	3/8"	14.6	77	1	13,72
4305A-7/16	7/16"	16.5	77	1	13,72
4305A-1/2	1/2"	19	77	1	13,72
4305A-9/16	9/16"	20.3	77	1	13,72
4305A-19/32	19/32"	21.5	77	1	14,00
4305A-5/8	5/8"	22.8	77	1	14,27
4305A-21/32	21/32"	24	77	1	14,27
4305A-11/16	11/16"	25	77	1	15,02
4305A-3/4	3/4"	26.5	77	1	15,02
4305A-25/32	25/32"	27.8	77	1	16,31
4305A-13/16	13/16"	29	77	1	17,57
4305A-7/8	7/8"	30	77	1	17,57
4305A-15/16	1-15/16"	32.8	77	1	19,91
4305A-31/32	1-31/32"	34	77	1	21,29
4305A-1	1"	32.8	77	1	21,29
4305A-1-1/16	1-1/16"	36.5	77	1	21,29
4305A-1-1/8	1-1/8"	37.8	77	1	25,93
4305A-1-3/16	1-3/16"	40	77	1	25,93
4305A-1-1/4	1-1/4"	42.8	77	1	25,93
4305A-1-5/16	1-5/16"	44.2	77	1	43,97
4305A-1-3/8	1-3/8"	46.2	77	1	45,46
4305A-1-7/16	1-7/16"	48	77	1	47,69
4305A-1-1/2	1-1/2"	49	77	1	51,26
4305A-1-13/16	1-13/16"	59	77	1	69,03



CHIAVI A BUSSOLA A MANO BOCCA SURFACE DRIVE LUNGHE

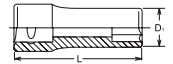

Koken articolo	mm	D mm	L mm		€uro
4310M-8	8	13.2	77	1	13,37
4310M-9	9	13.8	77	1	13,37
4310M-10	10	15.3	77	1	13,37
4310M-11	11	16.5	77	1	13,37
4310M-12	12	17.8	77	1	13,37
4310M-13	13	19	77	1	13,37
4310M-14	14	20.3	77	1	13,37
4310M-15	15	21.5	77	1	13,64
4310M-16	16	22.8	77	1	13,92
4310M-17	17	24	77	1	13,92
4310M-18	18	25	77	1	14,63
4310M-19	19	26.5	77	1	14,63
4310M-20	20	27.8	77	1	15,90
4310M-21	21	29	77	1	17,13
4310M-22	22	30	77	1	17,13
4310M-23	23	31.5	77	1	18,45
4310M-24	24	32.8	77	1	19,42
4310M-25	25	34	77	1	20,74
4310M-26	26	35	77	1	20,74
4310M-27	27	36.5	77	1	20,74
4310M-28	28	37.8	77	1	24,15
4310M-29	29	39	77	1	25,27
4310M-30	30	40	77	1	25,27
4310M-31	31	41.5	77	1	25,27
4310M-32	32	42.8	77	1	25,27
4310M-34	34	45.2	77	1	44,30



CHIAVI A BUSSOLA A MANO BOCCA TORX® LUNGHE

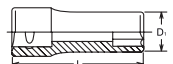

Koken articolo		D mm	L mm		€uro
4325-E 8	E 8	10.7	77	1	15,32
4325-E10	E10	13.2	77	1	15,32
4325-E11	E11	13.8	77	1	15,32
4325-E12	E12	14.6	77	1	15,32
4325-E14	E14	16.5	77	1	15,70
4325-E16	E16	19	77	1	15,70
4325-E18	E18	20.3	77	1	15,70
4325-E20	E20	22.8	77	1	17,77
4325-E22	E22	25	77	1	20,65
4325-E24	E24	26.6	77	1	20,65



TORX®	S mm	S mm	
E 4	3.70	E 16	14.60
E 5	4.60	E 18	16.50
E 6	5.60	E 20	18.30
E 7	6.10	E 22	20.10
E 8	7.40	E 24	22.00
E 10	9.30	E 26	23.70
E 11	9.90	E 28	25.50
E 12	11.00	E 30	27.30
E 14	12.80	E 32	29.00



CHIAVI A BUSSOLA
A MANO BOCCA
OTTAGONALE

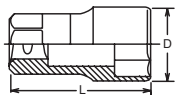

Koken articolo	mm	D mm	L mm		Euro
4300H-27-8P	27	34	57	1	31,38

per interruttori, Mercedes Benz e MAN



SERIE 10 PZ. CHIAVI A BUSSOLA LUNGHE
MISURE: 10, 11, 12, 13, 14, 15, 17
19, 21, 22 MM

Koken articolo	mm	D mm	L mm		Euro
RS4300M/10	10	12	110	1	131,78
RS4305M/10	15	17	110	1	131,78
RS4310M/10	22	22	110	1	134,67



SERIE 12 PZ. CHIAVI A BUSSOLA LUNGHE
MISURE: 10, 12, 13, 14, 15, 16, 17, 18
19, 20, 21, 22 MM

Koken articolo	mm	D mm	L mm		Euro
RS4300M/12	10	12	120	1	161,04

POLLICI



SERIE 10 PZ. CHIAVI A BUSSOLA
LUNGHE MISURE: 3/8", 7/16", 1/2"
9/16", 5/8", 11/16", 3/4", 13/16", 7/8", 15/16"

Koken articolo	mm	D mm	L mm		Euro
RS4300A/10	10	12	144,73	1	144,73
RS4305A/10	15	17	148,56	1	148,56



SERIE 7 PZ. CHIAVI A BUSSOLA BOCCA TORX®

Koken articolo	mm	D mm	L mm		Euro
RS4325/7	E10, E12, E14, E16, E18, E20, E24	10-24	140	1	112,50



CHIAVI A BUSSOLA
A MANO BOCCA
ESAGONALE
LUNGHE

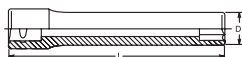

Koken articolo	mm	D mm	L mm		Euro
4300M-L110-17	17	23	110	1	36,41
4300M-L110-19	19	25.8	110	1	36,41
4300M-L110-21	21	26.8	110	1	38,56



CHIAVI A BUSSOLA
A MANO BOCCA
ESAGONALE

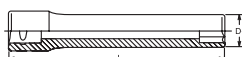

Koken articolo	mm	D mm	L mm		Euro
4300M-L120-8	8	13.2	120	1	43,48
4300M-L120-10	10	15.3	120	1	43,48
4300M-L120-12	12	17.8	120	1	43,48
4300M-L120-14	14	20.3	120	1	43,48
4300M-L120-16	16	22.8	120	1	44,17



CHIAVI A BUSSOLA
A MANO BOCCA
TORX®

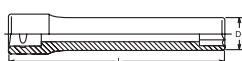

Koken articolo	mm	D mm	L mm		Euro
4325-L140-E 8	E 8	10.7	140	1	57,31
4325-L140-E10	E10	13.2	140	1	55,77
4325-L140-E12	E12	14.6	140	1	55,77
4325-L140-E14	E14	16.5	140	1	55,77



TORX BLOCCADADI

CHIAVI A BUSSOLA
A MANO BOCCA
TORX® BLOCCADADI



Koken articolo	mm	D mm	L mm		Euro
4325-L140-2B-E 8	E 8	10.7	140	1	63,53
4325-L140-2B-E10	E10	13.2	140	1	63,53
4325-L140-2B-E12	E12	14.6	140	1	63,53
4325-L140-2B-E14	E14	16.5	140	1	63,53



CHIAVI A BUSSOLA
A MANO BOCCA
POLIGONALE
LUNGHE

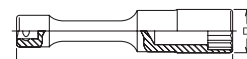

Koken articolo	mm	D mm	L mm		Euro
4117M-125-13	13	18.7	125	1	28,55
4117M-125-14	14	20.2	125	1	28,55
4117M-125-17	17	24	125	1	28,55
4117M-125-19	19	26.9	125	1	31,38
4117M-125-21	21	28.5	125	1	32,97
4117M-125-22	22	30	125	1	32,97
4117M-125-24	24	32	125	1	34,51
4117M-125-27	27	36.5	125	1	37,59
4117M-125-30	30	40	125	1	41,03
4117M-125-32	32	42	125	1	44,30
4117M-250-13	13	18.7	250	1	32,23
4117M-250-14	14	20.2	250	1	32,23
4117M-250-17	17	24	250	1	32,23
4117M-250-19	19	26.9	250	1	35,26
4117M-250-21	21	28.5	250	1	37,81
4117M-250-22	22	30	250	1	37,81
4117M-250-24	24	32	250	1	39,63
4117M-250-27	27	36.5	250	1	42,87
4117M-250-30	30	40	250	1	46,59
4117M-250-32	32	42	250	1	48,70





ESAGONO

CHIAVI A BUSSOLA A MANO SNODATE BOCCA ESAGONALE

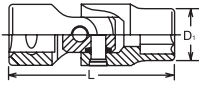

Koken articolo	mm	D ₁ mm	L mm		Euro
4440M-9	9	14	62.8	1	27,97
4440M-10	10	15.3	63.3	1	27,97
4440M-11	11	16.5	64.5	1	27,97
4440M-12	12	17.8	65	1	27,97
4440M-13	13	19	65.9	1	28,96
4440M-14	14	20.3	65.9	1	28,96
4440M-15	15	21.5	67.5	1	28,96
4440M-16	16	22.8	68	1	28,96
4440M-17	17	24	69	1	28,96
4440M-18	18	25.3	69	1	29,67
4440M-19	19	26.5	71	1	29,67
4440M-20	20	27.8	71	1	30,58
4440M-21	21	29	72	1	30,58
4440M-22	22	30.3	72	1	30,58

POLLICI



ESAGONO

CHIAVI A BUSSOLA A MANO SNODATE BOCCA ESAGONALE

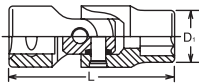



Koken articolo	pollici	D mm	L mm		Euro
4440A-3/8	3/8"	14.8	63.3	1	30,14
4440A-7/16	7/16"	16.5	64.5	1	30,14
4440A-1/2	1/2"	19	65.9	1	31,16
4440A-9/16	9/16"	20.3	65.9	1	31,16
4440A-5/8	5/8"	22.8	68	1	31,16
4440A-11/16	11/16"	24.6	69	1	31,96
4440A-3/4	3/4"	26.5	71	1	31,96
4440A-7/8	7/8"	30.3	72	1	32,92

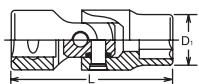

TORX®

CHIAVI A BUSSOLA A MANO SNODATE BOCCA TORX





Koken articolo		D mm	L mm		Euro
4440T-E10	E10	13.2	62	1	31,05
4440T-E12	E12	15	63.3	1	31,05
4440T-E14	E14	16.3	64.5	1	31,05
4440T-E16	E16	18.8	65	1	31,05
4440T-E18	E18	20.4	66.5	1	31,05

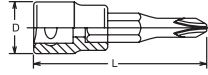

PHILLIPS®

CHIAVI A BUSSOLA A CROCE PHILLIPS®





Koken articolo		D mm	L mm		Euro
4000-60 (PH)-2	PH2	22	60	1	10,67
4000-60 (PH)-3	PH3	22	60	1	10,67
4000-60 (PH)-4	PH4	22	60	1	10,67

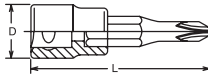

POZIDRIV®

CHIAVI A BUSSOLA A CROCE POZIDRIV®





Koken articolo		D mm	L mm		Euro
4000-60-PZ2	PZ2	22	60	1	11,80
4000-60-PZ3	PZ3	22	60	1	11,80

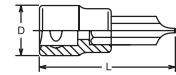

TAGLIO

CHIAVI A BUSSOLA A TAGLIO





Koken articolo		D mm	L mm		Euro
4005-60-8	1.2x8	22	60	1	12,13
4005-60-10	1.6x10	22	60	1	12,84
4005-60-12	2.0x12	23	60	1	12,84
4005-60-14	2.5x14	23	60	1	13,75
4005-60-16	2.5x16	24	60	1	14,27

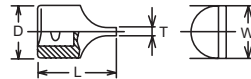

TAGLIO

CHIAVI A BUSSOLA A TAGLIO





Koken articolo		T x W	D mm	L mm		Euro
4101-1	2.7x18.6	22	40	1	16,36	
4101-2	3.7x24	24	40	1	16,67	
4101-3	3.7x30	30	40	1	27,09	

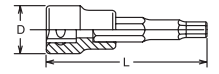

ESAGONO

CHIAVI A BUSSOLA MASCHIO ESAGONALE



Koken articolo		D mm	L mm		Euro
4010M-50-4	4	22	50	1	8,83
4010M-50-5	5	22	50	1	8,83
4010M-50-6	6	22	50	1	8,83
4010M-50-7	7	22	50	1	9,35
4010M-50-8	8	22	50	1	9,35
4010M-50-9	9	22	50	1	9,35
4010M-50-10	10	22	50	1	9,35
4010M-50-12	12	23	50	1	10,01
4010M-50-13	13	24	50	1	10,81
4010M-50-14	14	24	50	1	10,81
4010M-50-16	16	25	50	1	12,18
4010M-50-17	17	25	50	1	12,18
4010M-50-18	18	27	50	1	13,75
4010M-50-19	19	27	50	1	13,75
4010M-75-4	4	22	75	1	9,30
4010M-75-5	5	22	75	1	9,30
4010M-75-6	6	22	75	1	9,30
4010M-75-7	7	22	75	1	9,68
4010M-75-8	8	22	75	1	9,68
4010M-75-9	9	22	75	1	9,68
4010M-75-10	10	22	75	1	9,68
4010M-75-11	11	23	75	1	10,67
4010M-75-12	12	23	75	1	10,40
4010M-75-13	13	24	75	1	11,25
4010M-75-14	14	24	75	1	11,25
4010M-75-16	16	25	75	1	12,24
4010M-75-17	17	25	75	1	12,24
4010M-75-18	18	27	75	1	14,11
4010M-75-19	19	27	75	1	14,11
4010M-100-4	4	22	100	1	9,98
4010M-100-5	5	22	100	1	9,98
4010M-100-6	6	22	100	1	9,98
4010M-100-7	7	22	100	1	10,15
4010M-100-8	8	22	100	1	10,15
4010M-100-9	9	22	100	1	10,67
4010M-100-10	10	22	100	1	10,67
4010M-100-12	12	23	100	1	11,25
4010M-100-13	13	24	100	1	12,43
4010M-100-14	14	24	100	1	12,43
4010M-100-16	16	25	100	1	14,00
4010M-100-17	17	25	100	1	14,00
4010M-100-18	18	27	100	1	15,37
4010M-100-19	19	27	100	1	15,37
4010M-160-4	4	22	160	1	11,77
4010M-160-5	5	22	160	1	11,77
4010M-160-6	6	22	160	1	11,77
4010M-160-7	7	22	160	1	12,13
4010M-160-8	8	22	160	1	12,13
4010M-160-10	10	22	160	1	13,01
4010M-160-12	12	23	160	1	13,89
4010M-160-14	14	24	160	1	15,21
4010M-160-17	17	25	160	1	17,19
4010M-160-19	19	27	160	1	19,03

POLLICI

NEW

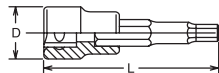

ESAGONO

CHIAVI A BUSSOLA MASCHIO ESAGONALE IN POLLICI

Koken articolo	pollici	D mm	L mm		Euro
4010A-60-5/32	5/32"	22	60	1	10,45
4010A-60-3/16	3/16"	22	60	1	10,45
4010A-60-7/32	7/32"	22	60	1	10,45
4010A-60-1/4	1/4"	22	60	1	10,45
4010A-60-9/32	9/32"	22	60	1	11,28
4010A-60-5/16	5/16"	22	60	1	11,28
4010A-60-11/32	11/32"	22	60	1	11,58
4010A-60-3/8	3/8"	22	60	1	11,58
4010A-60-7/16	7/16"	23	60	1	12,13
4010A-60-1/2	1/2"	24	60	1	13,50
4010A-60-9/16	9/16"	25	60	1	13,50
4010A-60-5/8	5/8"	25	60	1	13,78
4010A-60-3/4	3/4"	27	60	1	15,57



ESAGONO

SERIE 10 PZ. CHIAVI A BUSSOLA MASCHIO ESAGONALE

Koken articolo	mm	L mm		Euro
RS4010M/10-L50	4, 5, 6, 7, 8, 10, 12, 14, 17, 19	50	1	98,45
RS4010M/10-L75	4, 5, 6, 7, 8, 10, 12, 14, 17, 19	75	1	101,86
NEW RS4010A/10-L60	3/16", 7/32", 1/4", 5/16", 3/8", 7/16", 1/2", 9/16", 5/8", 3/4"	60	1	119,71

POLLICI

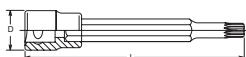

POLIGONALE

CHIAVI A BUSSOLA MASCHIO POLIGONALE PER TOYOTA

Koken articolo	mm	D mm	L mm		Euro
4010M-100-8-12P	8	23	100	1	16,06
4010M-100-10-12P	10	23	100	1	16,89
4010M-120-8-12P	8	23	120	1	17,19
4010M-120-10-12P	10	23	120	1	17,24

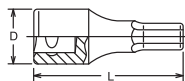

ESAGONO

CHIAVI A BUSSOLA MASCHIO ESAGONALE INTEGRALI

Koken articolo	mm	D mm	L mm		Euro
4012M-43-4	4	21.1	43	1	10,62
4012M-43-5	5	21.1	43	1	10,62
4012M-43-6	6	21.1	43	1	10,62
4012M-43-7	7	21.1	43	1	10,62
4012M-43-8	8	21.1	43	1	10,62
4012M-43-9	9	21.1	43	1	10,62
4012M-43-10	10	23	43	1	10,86
4012M-43-11	11	24	43	1	11,77
4012M-43-12	12	24	43	1	11,77
4012M-43-13	13	24	43	1	11,77
4012M-43-14	14	24	43	1	11,77
4012M-43-15	15	24	43	1	11,91
4012M-43-16	16	24	43	1	11,91
4012M-43-17	17	24	43	1	11,91
4012M-43-18	18	24	43	1	12,13
4012M-43-19	19	24	43	1	12,13
4012M-43-20	20	24	43	1	17,41
4012M-43-21	21	24	43	1	17,41
4012M-43-22	22	24	43	1	17,41
4012M-43-23	23	24	43	1	18,18
4012M-43-24	24	24	43	1	18,29
4012M-43-27	27	24	43	1	22,58
4012M-60-4	4	21.1	60	1	11,52
4012M-60-5	5	21.1	60	1	11,52
4012M-60-6	6	21.1	60	1	11,52
4012M-60-7	7	21.1	60	1	11,52
4012M-60-8	8	21.1	60	1	11,52
4012M-60-9	9	21.1	60	1	11,61
4012M-60-10	10	23	60	1	11,61
4012M-60-11	11	24	60	1	12,43
4012M-60-12	12	24	60	1	12,43
4012M-60-13	13	24	60	1	12,62
4012M-60-14	14	24	60	1	12,62
4012M-60-15	15	24	60	1	13,45
4012M-60-16	16	24	60	1	13,45
4012M-60-17	17	24	60	1	13,45
4012M-60-18	18	24	60	1	13,94
4012M-60-19	19	24	60	1	13,94
4012M-60-21	21	24	60	1	21,15
4012M-60-22	22	24	60	1	21,81
4012M-60-23	23	24	60	1	22,41
4012M-60-24	24	24	60	1	22,41

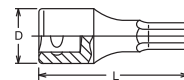

ESAGONO

CHIAVI A BUSSOLA MASCHIO ESAGONALE INTEGRALI

Koken articolo	mm	D mm	L mm		Euro
4012M-75-4	4	21.1	75	1	12,43
4012M-75-5	5	21.1	75	1	12,43
4012M-75-6	6	21.1	75	1	12,43
4012M-75-7	7	21.1	75	1	12,43
4012M-75-8	8	21.1	75	1	12,43
4012M-75-9	9	21.1	75	1	12,95
4012M-75-10	10	23	75	1	12,95
4012M-75-11	11	24	75	1	13,50
4012M-75-12	12	24	75	1	13,50
4012M-75-13	13	24	75	1	13,83
4012M-75-14	14	24	75	1	13,83
4012M-75-15	15	24	75	1	15,18
4012M-75-16	16	24	75	1	15,18
4012M-75-17	17	24	75	1	15,18
4012M-75-18	18	24	75	1	16,67
4012M-75-19	19	24	75	1	16,67
NEW 4012M-75-22	22	26	75	1	24,72
NEW 4012M-75-24	24	27.9	75	1	24,72
4012M-100-4	4	21.1	100	1	16,36
4012M-100-5	5	21.1	100	1	16,36
4012M-100-6	6	21.1	100	1	16,36
4012M-100-7	7	21.1	100	1	16,36
4012M-100-8	8	21.1	100	1	16,36
4012M-100-9	9	21.1	100	1	16,94
4012M-100-10	10	23	100	1	16,94
4012M-100-11	11	24	100	1	17,66
4012M-100-12	12	24	100	1	17,66
4012M-100-13	13	24	100	1	17,85
4012M-100-14	14	24	100	1	17,85
4012M-100-15	15	24	100	1	19,99
4012M-100-16	16	24	100	1	19,99
4012M-100-17	17	24	100	1	19,99
4012M-100-18	18	24	100	1	22,58
4012M-100-19	19	24	100	1	22,58



ESAGONO

SERIE 10 PZ. CHIAVI A BUSSOLA BOCCA ESAGONALE

Koken articolo	mm	L mm		Euro
RS4012M/10-L60	4, 5, 6, 7, 8, 10, 12, 14, 17, 19	60	1	118,36
POLLICI RS4012A/10-L60	3/16", 7/32", 1/4", 5/16", 3/8", 7/16", 1/2", 9/16", 5/8", 3/4"	60	1	125,37



POLLICI



ESAGONO

CHIAVI A BUSSOLA MASCHIO ESAGONALE INTEGRALI

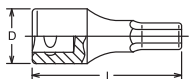

Koken articolo	pollici	D mm	L mm		Euro
4012A-43-5/32	5/32"	21.1	43	1	11,41
4012A-43-3/16	3/16"	21.1	43	1	11,41
4012A-43-7/32	7/32"	21.1	43	1	11,41
4012A-43-1/4	1/4"	21.1	43	1	11,41
4012A-43-9/32	9/32"	21.1	43	1	11,41
4012A-43-5/16	5/16"	21.1	43	1	11,41
4012A-43-11/32	11/32"	21.1	43	1	11,41
4012A-43-3/8	3/8"	23	43	1	11,69
4012A-43-7/16	7/16"	25	43	1	12,65
4012A-43-1/2	1/2"	25	43	1	12,65
4012A-43-9/16	9/16"	25	43	1	12,65
4012A-43-5/8	5/8"	26	43	1	12,82
4012A-43-3/4	3/4"	26	43	1	13,09
4012A-43-7/8	7/8"	26	43	1	18,76
4012A-60-5/32	5/32"	21.1	60	1	12,13
4012A-60-3/16	3/16"	21.1	60	1	12,13
4012A-60-7/32	7/32"	21.1	60	1	12,13
4012A-60-1/4	1/4"	21.1	60	1	12,13
4012A-60-9/32	9/32"	21.1	60	1	12,13
4012A-60-5/16	5/16"	21.1	60	1	12,13
4012A-60-11/32	11/32"	21.1	60	1	12,16
4012A-60-3/8	3/8"	21.5	60	1	12,16
4012A-60-7/16	7/16"	24	60	1	13,09
4012A-60-1/2	1/2"	24	60	1	13,23
4012A-60-9/16	9/16"	24	60	1	13,23
4012A-60-5/8	5/8"	24	60	1	14,16
4012A-60-3/4	3/4"	24	60	1	14,63
4012A-60-7/8	7/8"	26	60	1	22,94
4012A-75-5/32	5/32"	21.1	75	1	13,06
4012A-75-3/16	3/16"	21.1	75	1	13,06
4012A-75-7/32	7/32"	21.1	75	1	13,06
4012A-75-1/4	1/4"	21.1	75	1	13,06
4012A-75-9/32	9/32"	21.1	75	1	13,06
4012A-75-5/16	5/16"	21.1	75	1	13,06
4012A-75-11/32	11/32"	21.1	75	1	13,61
4012A-75-3/8	3/8"	21.5	75	1	13,61
4012A-75-7/16	7/16"	24	75	1	14,22
4012A-75-1/2	1/2"	24	75	1	14,49
4012A-75-9/16	9/16"	24	75	1	14,49
4012A-75-5/8	5/8"	24	75	1	15,92
4012A-75-3/4	3/4"	24	75	1	17,49
4012A-75-7/8	7/8"	26	75	1	25,96
4012A-100-5/32	5/32"	21.1	100	1	17,22
4012A-100-3/16	3/16"	21.1	100	1	17,22
4012A-100-7/32	7/32"	21.1	100	1	17,22
4012A-100-1/4	1/4"	21.1	100	1	17,22
4012A-100-9/32	9/32"	21.1	100	1	17,22
4012A-100-5/16	5/16"	21.1	100	1	17,22
4012A-100-11/32	11/32"	21.1	100	1	17,79
4012A-100-3/8	3/8"	21.5	100	1	17,79
4012A-100-7/16	7/16"	24	100	1	18,51
4012A-100-1/2	1/2"	24	100	1	18,78
4012A-100-9/16	9/16"	24	100	1	18,78
4012A-100-5/8	5/8"	24	100	1	20,96
4012A-100-3/4	3/4"	24	100	1	23,76



XZN

CHIAVI A BUSSOLA MASCHIO XZN

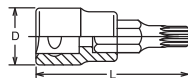

Koken articolo		D mm	L mm		Euro
4020-60-M 5	M 5	22	60	1	11,69
4020-60-M 6	M 6	22	60	1	11,69
4020-60-M 8	M 8	22	60	1	11,96
4020-60-M10	M10	23	60	1	12,13
4020-60-M12	M12	23	60	1	12,79
4020-60-M14	M14	23	60	1	13,31
4020-60-M16	M16	25	60	1	19,64
4020-60-M18	M18	27	60	1	19,64
4020-100-M 5	M 5	22	100	1	12,49
4020-100-M 6	M 6	22	100	1	12,49
4020-100-M 8	M 8	22	100	1	12,49
4020-100-M10	M10	23	100	1	13,59
4020-100-M12	M12	23	100	1	14,52
4020-100-M14	M14	23	100	1	15,51
4020-100-M16	M16	25	100	1	22,36
4020-100-M18	M18	27	100	1	38,56
4020-120-M 5	M 5	22	120	1	13,17
4020-120-M 6	M 6	22	120	1	13,17
4020-120-M 8	M 8	22	120	1	13,17
4020-120-M10	M10	23	120	1	14,16
4020-120-M12	M12	23	120	1	14,99
4020-120-M14	M14	23	120	1	17,82
4020-140-M 5	M 5	22	140	1	15,37
4020-140-M 6	M 6	22	140	1	15,37
4020-140-M 8	M 8	22	140	1	15,37
4020-140-M10	M10	23	140	1	15,51
4020-140-M12	M12	23	140	1	17,02
4020-140-M14	M14	23	140	1	18,56

XZN



SERIE 6 PZ. CHIAVI A BUSSOLA BOCCA XZN

Koken articolo		L mm		Euro
RS4020/6-L60	M5, M6, M8, M10, M12, M14	60	1	71,47
RS4020/6-L100	M5, M6, M8, M10, M12, M14	100	1	75,57

XZN

	S mm	S mm	
M 4	3,60	M12	11,50
M 5	4,80	M14	13,30
M 6	6,10	M16	15,70
M 8	7,30	M18	16,90
M10	9,70		



XZN CON FORO

CHIAVI A BUSSOLA MASCHIO XZN CON FORO

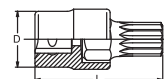

Koken articolo		D mm	L mm		Euro
4020-60-MH	MH16	25	60	1	32,42

Per tappo della scatola del cambio AUDI, VW, PORSCHE



TORX®

CHIAVI A BUSSOLA MASCHIO TORX®

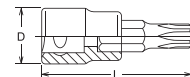

Koken articolo		D mm	L mm		Euro
4025-60-T15	TX 15	22	60	1	10,59
4025-60-T20	TX 20	22	60	1	10,59
4025-60-T25	TX 25	22	60	1	10,59
4025-60-T27	TX 27	22	60	1	10,59
4025-60-T30	TX 30	22	60	1	10,59
4025-60-T35	TX 35	22	60	1	14,36
4025-60-T40	TX 40	22	60	1	12,07
4025-60-T45	TX 45	22	60	1	12,07
4025-60-T50	TX 50	22	60	1	12,07
4025-60-T55	TX 55	23	60	1	13,75
4025-60-T60	TX 60	24	60	1	14,25
4025-60-T70	TX 70	24	60	1	26,10
4025-60-T80	TX 80	24	60	1	26,59
4025-100-T20	TX 20	22	100	1	14,30
4025-100-T25	TX 25	22	100	1	14,30
4025-100-T27	TX 27	22	100	1	14,30
4025-100-T30	TX 30	22	100	1	14,30
4025-100-T40	TX 40	22	100	1	14,91
4025-100-T45	TX 45	22	100	1	14,91
4025-100-T50	TX 50	22	100	1	14,91
4025-100-T55	TX 55	23	100	1	16,58
4025-100-T60	TX 60	24	100	1	16,86
4025-100-T70	TX 70	24	100	1	34,13
4025-140-T20	TX 20	22	140	1	16,58
4025-140-T25	TX 25	22	140	1	16,58
4025-140-T27	TX 27	22	140	1	16,58
4025-140-T30	TX 30	22	140	1	16,58
4025-140-T40	TX 40	22	140	1	17,30
4025-140-T45	TX 45	22	140	1	17,30
4025-140-T50	TX 50	22	140	1	17,30
4025-140-T55	TX 55	23	140	1	18,04
4025-140-T60	TX 60	24	140	1	18,37
4025-140-T70	TX 70	24	140	1	39,19
4025-140-T80	TX 80	24	140	1	42,13

KOKEN 1/2"

TORX®

SERIE 9 PZ. CHIAVI A BUSSOLA BOCCA TORX®

Koken articolo	L mm	Euro
TX 20, 25, 27, RS4025/9-L60	60	102,47

TORXplus®

CHIAVI A BUSSOLA MASCHIO TORX® PLUS

Koken articolo	D mm	L mm	Euro
4025-60-20IP	22	60	14,08
4025-60-25IP	22	60	14,08
4025-60-27IP	22	60	14,08
4025-60-30IP	22	60	14,08
4025-60-40IP	22	60	15,79
4025-60-45IP	22	60	15,79
4025-60-50IP	22	60	15,79
4025-60-55IP	23	60	17,77
4025-60-60IP	24	60	18,48
4025-60-70IP	25	60	33,77
4025-100-40IP	22	100	18,12
4025-100-45IP	22	100	18,12
4025-100-50IP	22	100	18,12
4025-100-55IP	23	100	20,24
4025-100-60IP	24	100	20,24
4025-100-70IP	25	100	40,81

TORXplus®

SERIE 9 PZ. CHIAVI A BUSSOLA BOCCA TORX® PLUS

Koken articolo	L mm	Euro
RS4025/9-IP	60	129,58

TORXplus®	S mm	S mm	
8 IP	2.30	30 IP	5.60
9 IP	2.50	40 IP	6.70
10 IP	2.70	45 IP	7.90
15 IP	3.30	50 IP	8.90
20 IP	3.90	55 IP	11.30
25 IP	4.50	60 IP	13.30
27 IP	5.00		

CHIAVI A BUSSOLA MASCHIO RIBE

Koken articolo	D mm	L mm	Euro
4027-60-M5	M 5	22 60	15,76
4027-60-M6	M 6	22 60	15,76
4027-60-M7	M 7	22 60	16,47
4027-60-M8	M 8	22 60	16,47
4027-60-M9	M 9	22 60	17,90
4027-60-M10	M10	22 60	17,90
4027-60-M12	M12	23 60	19,91
4027-60-M13	M13	24 60	22,33
4027-60-M14	M14	24 60	22,33
4027-60-M16	M16	24 60	24,67
4027-100-M5	M 5	22 100	16,06
4027-100-M6	M 6	22 100	16,28
4027-100-M7	M 7	22 100	17,19
4027-100-M8	M 8	22 100	17,19
4027-100-M9	M 9	22 100	19,91
4027-100-M10	M10	22 100	20,49
4027-100-M12	M12	23 100	22,39
4027-100-M13	M13	24 100	24,39
4027-100-M14	M14	24 100	24,39
4027-100-M16	M16	24 100	26,43
4027-140-M8	M8	22 140	18,87
4027-140-M10	M10	22 140	21,12
4027-140-M12	M12	23 140	24,78
4027-140-M14	M14	24 140	25,77
4027-140-M16	M16	24 140	27,50

RIBE

SERIE 7 PZ. CHIAVI A BUSSOLA BOCCA RIBE

Koken articolo	L mm	Euro
RS4027/7-L60	60	125,90

RIBE

CHIAVI A BUSSOLA MASCHIO RIBE PER VW E AUDI

Koken articolo	D mm	L mm	Euro
ST4027-140	23	140	19,86

RIBE

	S mm	W mm
M 5	5.00	1.20
M 6	6.00	1.30
M 7	7.00	1.40
M 8	8.00	1.80
M 9	9.00	2.00
M 10	10.00	2.30
M 12	12.00	2.60
M 13	13.00	3.10
M 14	14.00	3.20
M 16	16.00	3.60

MECCANISMO 24 DENTI

CRICCHETTO PORTABUSSOLA REVERSIBILE

Koken articolo	D mm	T mm	L mm	Euro
3749S-1/2	34	29	110	48,90

MECCANISMO 24 DENTI

CRICCHETTO PORTABUSSOLA REVERSIBILE CON PULSANTE DI SBLOCCAGGIO RAPIDO

Koken articolo	D mm	T mm	L mm	Euro
3749SB-1/2	34	29	110	60,17

MECCANISMO 30 DENTI

CRICCHETTO PORTABUSSOLA REVERSIBILE

Koken articolo	D mm	T mm	L mm	Euro
4750J	38	35,9	250	70,32

MECCANISMO 30 DENTI

CRICCHETTO PORTABUSSOLA REVERSIBILE CON PULSANTE DI SBLOCCAGGIO RAPIDO

Koken articolo	D mm	T mm	L mm	Euro
4750JB	38	35,9	250	86,21



MECCANISMO 30 DENTI

CRICCHETTO PORTABUSSOLA REVERSIBILE CON PULSANTE DI SBLOCCAGGIO RAPIDO

Koken	D mm	T mm	L mm		Euro
articolo					
4750PB	38	35,9	250	1	85,03

MECCANISMO 24 DENTI

CRICCHETTO PORTABUSSOLA REVERSIBILE CON PULSANTE DI SBLOCCAGGIO RAPIDO

Koken	D mm	T mm	L mm		Euro
articolo					
4753PB	38	36,2	250	1	71,28

MECCANISMO 24 DENTI

CRICCHETTO PORTABUSSOLA REVERSIBILE SNODATO - TIPO LUNGO

Koken	D mm	T mm	L mm		Euro
articolo					
4774P	38	36,2	330	1	86,43
4774P-450	38	36,2	450	1	109,78

MECCANISMO 45 DENTI

CRICCHETTO PORTABUSSOLA REVERSIBILE

Koken	D mm	T mm	L mm		Euro
articolo					
4752J	35	38,8	250	1	83,96

MECCANISMO 24 DENTI

CRICCHETTO PORTABUSSOLA REVERSIBILE TIPO LUNGO

Koken	D mm	T mm	L mm		Euro
articolo					
4749J-380	44,6	33	380	1	83,33

MECCANISMO 24 DENTI

CRICCHETTO PORTABUSSOLA REVERSIBILE SNODATO CON PULSANTE DI SBLOCCAGGIO RAPIDO - TIPO LUNGO

Koken	D mm	T mm	L mm		Euro
articolo					
4774PB	38	36,2	330	1	94,52

MECCANISMO 24 DENTI

CRICCHETTO PORTABUSSOLA REVERSIBILE

Koken	D mm	T mm	L mm		Euro
articolo					
4753J	38	36,2	250	1	61,82

MECCANISMO 24 DENTI

CRICCHETTO PORTABUSSOLA REVERSIBILE TIPO EXTRA LUNGO

Koken	D mm	T mm	L mm		Euro
articolo					
4753P-410	38	36,2	410	1	104,45

MECCANISMO 45 DENTI

ADATTATORE A CRICCHETTO

Koken	D mm	L mm		Euro
articolo				
4755	33,5	65	1	60,91

MECCANISMO 24 DENTI

CRICCHETTO PORTABUSSOLA REVERSIBILE

Koken	D mm	T mm	L mm		Euro
articolo					
4753P	38	36,2	250	1	60,03

MECCANISMO 24 DENTI

CRICCHETTO PORTABUSSOLA REVERSIBILE SNODATO - TIPO LUNGO

Koken	D mm	T mm	L mm		Euro
articolo					
4774J	38	36,2	330	1	89,82

ADATTATORE A MANOPOLA PORTABUSSOLA

Koken	D mm	L mm		Euro
articolo				
4756	38	34,6	1	24,78

MECCANISMO 24 DENTI

CRICCHETTO PORTABUSSOLA REVERSIBILE CON PULSANTE DI SBLOCCAGGIO RAPIDO

Koken	D mm	T mm	L mm		Euro
articolo					
4753JB	38	36,2	250	1	75,74

MECCANISMO 24 DENTI

CRICCHETTO PORTABUSSOLA REVERSIBILE SNODATO CON PULSANTE DI SBLOCCAGGIO RAPIDO - TIPO LUNGO

Koken	D mm	T mm	L mm		Euro
articolo					
4774JB	38	36,2	330	1	99,03

QUADRO MASCHIO SNODATO CON IMPUGNATURA

Koken	D mm	L mm		Euro
articolo				
4768J-380	28	380	1	50,08
4768J-450	28	450	1	53,60

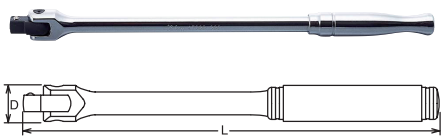

QUADRO MASCHIO SNODATO CON IMPUGNATURA

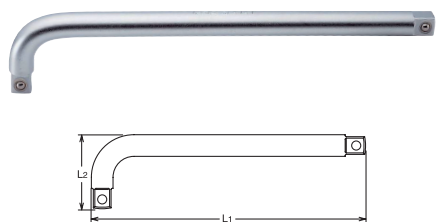
Koken articolo	D mm	L mm		Euro
4768P-380	28	380	1	48,70
4768P-450	28	450	1	53,90

DOPPIO QUADRO MASCHIO AD ANGOLO

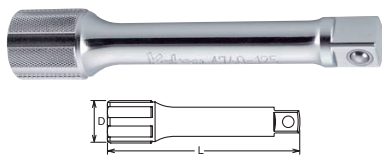
Koken articolo	L1 mm	L2 mm		Euro
4747	260	50	1	22,17

PROLUNGA CON ATTACCO QUADRO

Koken articolo	D mm	L mm		Euro
4760-50	24	50	1	12,07
4760-75	24	75	1	12,07
4760-100	24	100	1	13,89
4760-125	24	125	1	13,89
4760-150	24	150	1	16,61
4760-200	24	200	1	18,07
4760-250	24	250	1	18,07
4760-300	24	300	1	25,60
4760-400	24	400	1	34,27
4760-500	24	500	1	44,11
4760-600	24	600	1	43,48
4760-900	24	900	1	102,00
4760-1000	24	1000	1	102,00

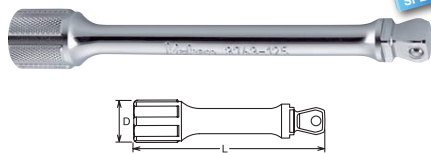

Koken articolo	DESCRIZIONE	Euro
PK4760/5	Set 5 prolunghe con attacco quadro	84,92
CARATTERISTICHE		
4760	50, 75, 125, 150, 250 mm	

PROLUNGA CON TESTA SFERICA

SISTEMA WOBBLE-FIX CON DUE MODALITÀ DI UTILIZZO:

- PROLUNGA TESTA SFERICA ANGOLO 15°
- PROLUNGA TRADIZIONALE

Koken articolo	D mm	L mm		Euro
4763-50	24	50	1	13,09
4763-75	24	75	1	15,81
4763-125	24	125	1	18,10
4763-150	24	150	1	24,15
4763-250	24	250	1	25,30
4763-400	24	400	1	55,39



SISTEMA WOBBLE-FIX CON DUE MODALITÀ DI UTILIZZO:

- PROLUNGA TESTA SFERICA ANGOLO 15°
- PROLUNGA TRADIZIONALE

Koken articolo	DESCRIZIONE	Euro
PK4763/5	Set 5 prolunghe con attacco quadro	108,90
CARATTERISTICHE		
4763	50, 75, 125, 150, 250 mm	

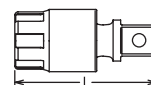

SNODO

Koken articolo	L mm		Euro
4770	62,4	1	24,09

SNODO

Koken articolo	L mm		Euro
4771	58,5	1	30,66

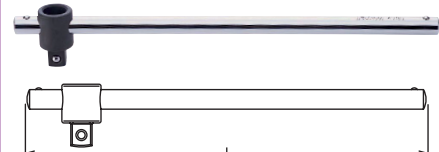

QUADRO MASCHIO CON MANOVELLA

Koken articolo	H mm	L mm		Euro
4780-400	100	400	1	30,53



L'innovativa barra a forma ovale offre una maggiore durata e impedisce al quadro scorrevole di ruotare attorno l'asta.

QUADRO MASCHIO CON ASTA SCORREVOLE OVALE

Koken articolo	L mm		Euro
4785K	300	1	20,54

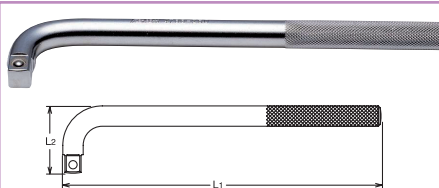

QUADRO MASCHIO AD ANGOLO

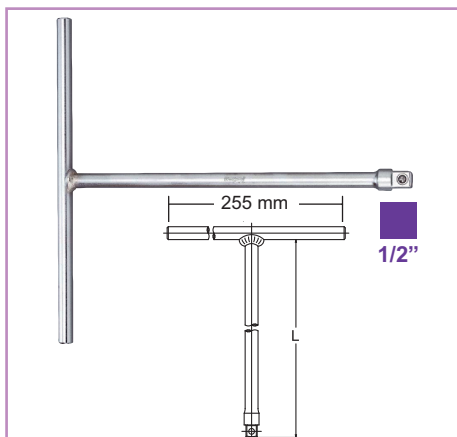
Koken articolo	L1 mm	L2 mm		Euro
4788-250K	250	53	1	21,89
4788-300K	300	53	1	23,32
4788-450K	450	53	1	31,16

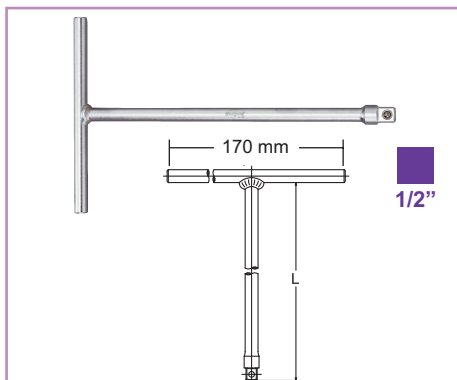

CHIAVI A "T" MASCHIO QUADRO 1/2"
LARGHEZZA IMPUGNATURA 255 MM

Koken articolo	pollici	L mm		Euro
4715-1/2	1/2"	267	1	22,47



CHIAVI A "T" MASCHIO QUADRO 1/2"
LARGHEZZA IMPUGNATURA 170 MM

Koken articolo	pollici	L mm		Euro
4715S-1/2	1/2"	267	1	22,47

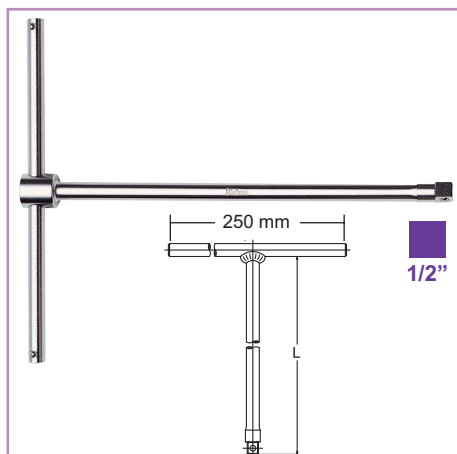

CHIAVI A "T" MASCHIO QUADRO 1/2" CON
ASTA SCORREVOLE LARGHEZZA 250 MM

Koken articolo	pollici	L mm		Euro
4715SL-1/2	1/2"	250	1	31,76

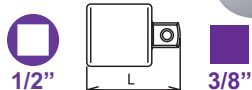

RACCORDO DI RIDUZIONE
QUADRO MASCHIO 3/8" E FEMMINA 1/2"

Koken articolo	L mm		Euro
4433A-35	35	1	11,25
4433A-75	75	1	13,64
4433A-125	125	1	13,64
4433A-250	250	1	18,56
4433A-600	600	1	38,72



RACCORDO DI RIDUZIONE
QUADRO MASCHIO 3/4" E FEMMINA 1/2"

Koken articolo	L mm		Euro
4466A	42	1	14,69



SERIE 22 PZ. CHIAVI A BUSSOLA
BOCCA ESAGONALE / POLIGONALE

Koken articolo	DESCRIZIONE		Euro
4251M-01	10, 11, 12, 13, 14, 15, 16, 17, 18, 19, 20, 21, 22, 23, 24, 25, 26, 27, 28, 29, 30, 32 MM	1	186,67
4251M-06	10, 11, 12, 13, 14, 15, 16, 17, 18, 19, 20, 21, 22, 23, 24, 25, 26, 27, 28, 29, 30, 32 MM	1	186,67



SERIE 13 PZ. CHIAVI A BUSSOLA
BOCCA ESAGONALE / POLIGONALE
CASSETTA METALLICA 168 X 60 X H 42 MM

Koken articolo	DESCRIZIONE		Euro
4252M-01	10, 11, 12, 13, 14, 15, 16, 17, 18, 19, 20, 21, 22 MM	1	94,99
4252M-06	10, 11, 12, 13, 14, 15, 16, 17, 18, 19, 20, 21, 22 MM	1	94,99



Koken articolo	DESCRIZIONE	Euro
P4241M-01	Cassetta metallica 28 Pz. 425 x 332 x h 65 mm	372,16

RICAMBI





BUSSOLE	DESCRIZIONE	Euro
ESAGONO 4401M	10, 11, 12, 13, 14, 15, 16, 17, 18, 19, 20, 21, 22, 23, 24, 25, 26, 27, 28, 29, 30, 32	
ACCESSORI	4753J	
	4760-125	
	4760-250	
	4768J-380	
	4770	
	4785	



KOKEN 1/2"



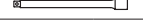
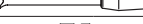



Koken articolo	DESCRIZIONE	Euro
P4241M-06	Cassetta metallica 28 Pz. 425 x 332 x h 65 mm	372,16

RICAMBI		
BUSSOLE  POLIGONALE	4405M	10, 11, 12, 13, 14, 15, 16, 17, 18, 19, 20, 21, 22, 23, 24, 25, 26, 27, 28, 29, 30, 32
	4753J	
	4760-125	
	4760-250	
	4768J-380	
ACCESSORI	4770	
	4785	



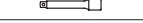
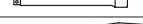
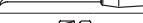
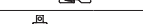



Koken articolo	DESCRIZIONE	Euro
4249M-01	Cassetta metallica 20 Pz. 445 x 190 x h 50 mm	256,55

RICAMBI		
BUSSOLE  ESAGONO	4401M	10, 11, 12, 13, 14, 15, 16, 17, 18, 19, 21, 22, 24, 27, 30
	4753J	
	4760-125	
	4760-250	
	4768J-380	
ACCESSORI	4770	
	4785	



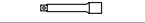
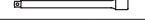
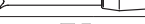



Koken articolo	DESCRIZIONE	Euro
4249M-06	Cassetta metallica 20 Pz. 445 x 190 x h 50 mm	256,55

RICAMBI		
BUSSOLE  POLIGONALE	4406M	10, 11, 12, 13, 14, 15, 16, 17, 18, 19, 21, 22, 24, 27, 30
	4753J	
	4760-125	
	4760-250	
	4768J-380	
ACCESSORI	4770	
	4785	



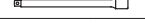
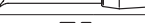



Koken articolo	DESCRIZIONE	Euro
4241M-01	Cassetta metallica 28 Pz. 446 x 266 x h 50 mm	396,85

RICAMBI		
BUSSOLE  ESAGONO	4401M	10, 11, 12, 13, 14, 15, 16, 17, 18, 19, 20, 21, 22, 23, 24, 25, 26, 27, 28, 29, 30, 32
	4753J	
	4760-125	
	4760-250	
	4768J-380	
ACCESSORI	4770	
	4785	



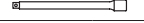
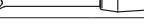





Koken articolo	DESCRIZIONE	Euro
4241M-06	Cassetta metallica 28 Pz. 446 x 266 x h 50 mm	396,85

RICAMBI		
BUSSOLE  POLIGONALE	4406M	10, 11, 12, 13, 14, 15, 16, 17, 18, 19, 20, 21, 22, 23, 24, 25, 26, 27, 28, 29, 30, 32
	4753J	
	4760-125	
	4760-250	
	4768J-380	
ACCESSORI	4770	
	4785	



Koken articolo	DESCRIZIONE	Euro
4241M-10	Cassetta metallica 28 Pz. 446 x 266 x h 50 mm	405,30

RICAMBI		
BUSSOLE  SURFACE DRIVE	4410M	10, 11, 12, 13, 14, 15, 16, 17, 18, 19, 20, 21, 22, 23, 24, 25, 26, 27, 28, 29, 30, 32
	4753J	
	4760-125	
	4760-250	
	4768J-380	
ACCESSORI	4770	
	4785	



POLLICI



Koken articolo	DESCRIZIONE	Euro
4241A-00	Cassetta metallica 19 Pz. 445 x 190 x h 50 mm	302,91
RICAMBI		
BUSSOLE ESAGONO	4400A	3/8", 7/16", 1/2", 9/16", 5/8", 11/16", 3/4", 13/16", 7/8", 15/16", 1-1/16", 1-1/8", 1-1/4"
	4753J	
ACCESSORI	4760-125	
	4760-250	
	4768J-380	
	4770	
	4785	

POLLICI



Koken articolo	DESCRIZIONE	Euro
4241A-05	Cassetta metallica 19 Pz. 445 x 190 x h 50 mm	302,91
RICAMBI		
BUSSOLE POLIGONALE	4405A	3/8", 7/16", 1/2", 9/16", 5/8", 11/16", 3/4", 13/16", 7/8", 15/16", 1-1/16", 1-1/8", 1-1/4"
	4753J	
ACCESSORI	4760-125	
	4760-250	
	4768J-380	
	4770	
	4785	



Koken articolo	DESCRIZIONE	Euro
4250M-01	Cassetta metallica 18 Pz. 445 x 190 x h 50 mm	249,45
RICAMBI		
BUSSOLE ESAGONO	4401M	10, 11, 12, 13, 14, 15, 17, 19, 22, 24, 27, 30, 32
	4753J	
ACCESSORI	4760-125	
	4760-250	
	4770	
	4785	



Koken articolo	DESCRIZIONE	Euro
4250M-06	Cassetta metallica 18 Pz. 445 x 190 x h 50 mm	249,45
RICAMBI		
BUSSOLE POLIGONALE	4406M	10, 11, 12, 13, 14, 15, 17, 19, 22, 24, 27, 30, 32
	4753J	
ACCESSORI	4760-125	
	4760-250	
	4770	
	4785	

MILLIMETRI
E POLLICI



Koken articolo	DESCRIZIONE	Euro
4272AM-01	Cassetta metallica 29 Pz. 445 x 190 x h 50 mm	318,59
RICAMBI		
BUSSOLE ESAGONO	4401M	10, 11, 12, 13, 14, 15, 16, 17, 18, 19, 21, 22, 24 mm
	4401A	3/8", 7/16", 1/2", 9/16", 5/8", 11/16", 3/4", 13/16", 7/8", 15/16", 1"
ACCESSORI	4753J	
	4760-125	
	4760-250	
	4768J-380	
	4770	
4785		

MILLIMETRI
E POLLICI



Koken articolo	DESCRIZIONE	Euro
4272AM-06	Cassetta metallica 29 Pz. 445 x 190 x h 50 mm	318,59
RICAMBI		
BUSSOLE POLIGONALE	4406M	10, 11, 12, 13, 14, 15, 16, 17, 18, 19, 21, 22, 24 mm
	4405A	3/8", 7/16", 1/2", 9/16", 5/8", 11/16", 3/4", 13/16", 7/8", 15/16", 1"
ACCESSORI	4753J	
	4760-125	
	4760-250	
	4768J-380	
	4770	
4785		



KOKEN 1/2"

PROMO



ALTA QUALITÀ MADE IN JAPAN



ESPOSITORE METALLICO 117 PEZZI CHIAVI A BUSSOLA

Koken articolo	DESCRIZIONE	TIPO BUSSOLE	NUMERO BUSSOLE	ATTACCO	Euro
S 4240M-01	CHIAVI A BUSSOLA ESAGONALI		117 PEZZI	 1/2"	790,16
S 4240M-06	CHIAVI A BUSSOLA POLIGONALI		117 PEZZI	 1/2"	790,16

CARATTERISTICHE

- espositore metallico: lunghezza 510 mm x larghezza 230 mm x altezza 150 mm
- bussole con attacco quadro femmina 1/2"
- con 117 bussole esagonali così assortite:

- 9 pezzi, bussole 10 mm
- 9 pezzi, bussole 11 mm
- 9 pezzi, bussole 12 mm
- 9 pezzi, bussole 13 mm
- 9 pezzi, bussole 14 mm
- 9 pezzi, bussole 15 mm
- 9 pezzi, bussole 16 mm
- 8 pezzi, bussole 17 mm
- 7 pezzi, bussole 19 mm
- 7 pezzi, bussole 21 mm
- 6 pezzi, bussole 22 mm
- 6 pezzi, bussole 23 mm
- 6 pezzi, bussole 24 mm
- 5 pezzi, bussole 27 mm
- 5 pezzi, bussole 30 mm
- 4 pezzi, bussole 32 mm

 1/2"  **ESAGONO**

BUSSOLE CHROM-VANADIUM - SATINATE
Attacco: 1/2"
impronta: ESAGONO



BGS articolo	mm	L mm		Euro
BGS 2908	8	40	1	3,31
BGS 2909	9	40	1	3,31
BGS 2910	10	40	1	3,31
BGS 2911	11	40	1	3,31
BGS 2912	12	40	1	3,31
BGS 2913	13	40	1	3,31
BGS 2914	14	40	1	3,31
BGS 2915	15	40	1	3,31
BGS 2916	16	40	1	3,53
BGS 2917	17	40	1	3,80
BGS 2918	18	40	1	4,14
BGS 2919	19	40	1	4,14
BGS 2920	20	40	1	4,40
BGS 2921	21	40	1	4,59
BGS 2922	22	40	1	5,12
4615-0230	23	40	1	5,29
BGS 2924	24	40	1	5,29
4615-0250	25	40	1	7,32
BGS 2926	26	45	1	7,93
BGS 2927	27	45	1	8,27
4615-0280	28	45	1	8,27
4615-0290	29	45	1	8,38
BGS 2930	30	45	1	8,73
BGS 2932	32	45	1	9,52
BGS 2934	34	45	1	9,98
BGS 2935 NEW	35	45	1	13,52
BGS 2936	36	45	1	17,33
BGS 9845 NEW	38	45	1	17,33

 1/2"  **POLIGONALE**

BUSSOLE CHROM-VANADIUM POLIGONALI - SATINATE
Attacco: 1/2"
impronta: POLIGONALI

PRO+ CV



BGS articolo	mm	L mm		Euro
BGS 10628	8	40	1	2,81
BGS 10629	9	40	1	2,81
BGS 10630	10	40	1	2,81
BGS 10631	11	40	1	2,81
BGS 10632	12	40	1	2,81
BGS 10633	13	40	1	3,06
BGS 10634	14	40	1	3,06
BGS 10635	15	40	1	3,06
BGS 10636	16	40	1	3,06
BGS 10637	17	40	1	2,81
BGS 10638	18	40	1	3,06
BGS 10639	19	40	1	3,06
BGS 10640	20	40	1	3,70
BGS 10641	21	40	1	3,70
BGS 10642	22	40	1	4,08
BGS 10644	24	40	1	4,34
BGS 10626 NEW	26	40	1	4,85
BGS 10645	27	40	1	5,61
BGS 10625 NEW	28	77	1	6,12
BGS 10646	30	40	1	6,63
BGS 10647	32	40	1	7,65
BGS 10648	34	40	1	11,99
BGS 10649	36	40	1	14,28

 1/2"  **SURFACE DRIVE**

BUSSOLE CHROM-VANADIUM - SATINATE SURFACE DRIVE
Attacco: 1/2"
impronta: SURFACE-DRIVE

PRO+ CV

BGS articolo	mm	L mm		Euro
BGS 2408	8	40	1	2,42
BGS 2409	9	40	1	2,42
BGS 2410	10	40	1	2,42
BGS 2411	11	40	1	2,42
BGS 2412	12	40	1	2,55
BGS 2413	13	40	1	2,55
BGS 2414	14	40	1	2,55
BGS 2415	15	40	1	2,55
BGS 2416	16	40	1	2,55
BGS 2417	17	40	1	2,81
BGS 2418	18	40	1	2,81
BGS 2419	19	40	1	3,06
BGS 2420	20	40	1	3,32
BGS 2421	21	40	1	3,44
BGS 2422	22	40	1	3,83
BGS 2424	24	40	1	4,08
BGS 2427	27	45	1	5,23
BGS 2428 NEW	28	45	1	5,61
BGS 2430	30	45	1	6,38
BGS 2432	32	45	1	6,89

POLLICI  1/2"  **ESAGONO**

BUSSOLE CHROM-VANADIUM - SATINATE IN POLLICI
Attacco: 1/2"
impronta: ESAGONO

BGS articolo	pollici	L mm		Euro
BGS 2770	3/8"	40	1	3,50
BGS 2771	7/16"	40	1	3,50
BGS 2772	1/2"	40	1	3,50
BGS 2773	9/16"	40	1	3,50
BGS 2774	5/8"	40	1	3,50
BGS 2775	11/16"	40	1	3,50
BGS 2776	3/4"	40	1	3,50
BGS 2777	13/16"	40	1	3,90
BGS 2778	7/8"	40	1	3,90
BGS 2779	15/16"	40	1	3,90
BGS 2787 NEW	1"	40	1	4,59
BGS 2784 NEW	1 1/16"	40	1	5,10
BGS 2788 NEW	1 1/8"	40	1	5,61
BGS 2786 NEW	1 1/4"	40	1	6,12

NEW



 **ESAGONO**

DESCRIZIONE
SET 6 PEZZI, INSERTI ANTI-GRAFFIO PER CHIAVI A BUSSOLA ESAGONALI



FM 31032 **Euro 8,00**

CARATTERISTICHE

- inserti speciali che, utilizzati all'interno delle bussole esagonali tradizionali, consentono di prevenire danni a parti cromate o verniciate o, più in generale, con trattamenti superficiali
- comprende:
 - inserto 8 mm, per bussola 12 mm, coppia 9 Nm
 - inserto 10 mm, per bussola 14 mm, coppia 17 Nm
 - inserto 12 mm, per bussola 16 mm, coppia 27 Nm
 - inserto 13 mm, per bussola 17 mm, coppia 45 Nm
 - inserto 15 mm, per bussola 19 mm, coppia 50 Nm
 - inserto 17 mm, per bussola 22 mm, coppia 79 Nm
- per uso con bussole esagonali metriche

 1/2"  **TORX®**

TORX® SATINATE
Attacco: 1/2"
impronta: TORX®

BGS articolo		L mm		Euro
BGS 6460	E 10	40	1	4,32
BGS 6461	E 11	40	1	4,32
BGS 6462	E 12	40	1	4,32
BGS 6464	E 14	40	1	4,32
BGS 6466	E 16	40	1	4,32
BGS 6418	E 18	40	1	4,70
BGS 6420	E 20	40	1	5,08
BGS 6422	E 22	40	1	5,08
BGS 6424	E 24	40	1	5,46

TORX®	S mm	S mm	
E 4	3.70	E 16	14.60
E 5	4.60	E 18	16.50
E 6	5.60	E 20	18.30
E 7	6.10	E 22	20.10
E 8	7.40	E 24	22.00
E 10	9.30	E 26	23.70
E 11	9.90	E 28	25.50
E 12	11.00	E 30	27.30
E 14	12.80	E 32	29.00

1/2"

BUSSOLE CHROM-VANADIUM MULTIMPRONTA SPLINE-DRIVE

Attacco: 1/2"

impronta: SPLINE DRIVE

BGS articolo	mm	L mm		Euro
BGS 10208	8	40	1	3,44
BGS 10209	9	40	1	3,44
BGS 10210	10	40	1	3,57
BGS 10211	11	40	1	3,57
BGS 10212	12	40	1	3,57
BGS 10213	13	40	1	3,57
BGS 10214	14	40	1	3,57
BGS 10215	15	40	1	3,57
BGS 10216	16	40	1	3,70
BGS 10217	17	40	1	3,95
BGS 10218	18	40	1	4,08
BGS 10219	19	40	1	4,34
BGS 10220	20	40	1	4,85
BGS 10221	21	40	1	4,85
BGS 10222	22	40	1	5,23
BGS 10224	24	40	1	5,48
BGS 10227	27	40	1	6,76
BGS 10230	30	45	1	6,89
BGS 10232	32	45	1	7,65

CARATTERISTICHE

- misure: 20 - 21 - 22 - 24 - 27 - 30 - 32 mm
- finitura cromata satinata
- zigrinate
- su guida metallica

CARATTERISTICHE

- misure: 20 - 21 - 22 - 24 - 27 - 30 - 32 mm
- finitura cromata satinata, zigrinate
- su guida metallica

CARATTERISTICHE

- misure: 3/8" - 7/16" - 1/2" - 9/16" - 5/8" - 11/16" - 3/4" - 13/16" - 7/8" - 15/16"
- finitura cromata satinata, zigrinate
- su guida metallica

CARATTERISTICHE

- misure: 3/8" - 7/16" - 1/2" - 9/16" - 5/8" - 11/16" - 3/4" - 13/16" - 7/8" - 15/16"
- finitura cromata satinata, zigrinate
- su guida metallica

CARATTERISTICHE

- misure: 10 - 11 - 12 - 13 - 14 - 15 - 16 - 17 - 18 - 19 - 21 mm
- finitura cromata satinata
- zigrinate
- su guida metallica

CARATTERISTICHE

- misure: 10 - 11 - 12 - 13 - 14 - 15 - 16 - 17 - 18 - 19 - 21 mm
- finitura cromata satinata
- zigrinate
- su guida metallica

CARATTERISTICHE



- nuova impronta Torx Plus
- angolo d'applicazione è di 0 gradi, rispetto i 15 gradi dell'impronta Torx tradizionale
- misure: 18EP - 20EP - 22EP - 24EP - 26EP - 28EP - 30EP - 32EP
- finitura cromata lucida
- su guida metallica
- utilizzo settore automotive e veicoli industriali



TRIANGOLO



BUSSOLE TRIANGOLARI

BGS articolo		L mm		Euro
BGS 7460	8	40	1	7,65
BGS 7461	10	40	1	7,65
BGS 7462	12	40	1	7,91
BGS 7463	15	40	1	8,54
BGS 7464	16,5	40	1	8,54

CARATTERISTICHE

- finitura cromata satinata
- zigrinate
- attacco quadro da 1/2"
- idonee per adattatore pompa iniettore VAG TDI, Iniettori Bosch, quadri di comando e barriere



BGS articolo	DESCRIZIONE	Euro
BGS 8608	SET 5 PZ, BUSSOLE TRIANGOLARI, M5 - M12 (8 - 16,5 MM)	34,43

CARATTERISTICHE

- Set bussole a triangolari: M5 - M6 - M8 - M10 - M12
- finitura cromata satinata
- zigrinate
- attacco quadro da 1/2"
- idonee per adattatore pompa iniettore VAG TDI, Iniettori Bosch, quadri di comando e barriere

POLLICI **NEW**



BGS articolo	DESCRIZIONE	Euro
BGS 2246	SET 23 PEZZI, BUSSOLE ESAGONALI IN POLLICI	62,48

CARATTERISTICHE

- bussole esagonali attacco 1/4": 5/32", 3/16", 7/32", 1/4", 9/32", 5/16", 11/32", 3/8", 7/16", 15/32"
- bussole esagonali attacco 1/2": 1/2", 9/16", 19/32", 5/8", 11/16", 3/4", 13/16", 7/8", 15/16", 1", 1-1/16", 1-1/8", 1-1/4"
- finitura satinata cromata
- zigrinate

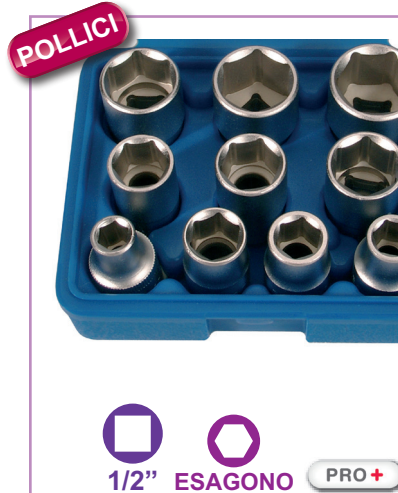

BGS articolo	DESCRIZIONE	Euro
BGS 2434	SET 10 PEZZI, BUSSOLE, ATT. 1/2, IN POLLICI	31,11

CARATTERISTICHE

- esagonali
- 3/8", 7/16", 1/2", 9/16", 5/8", 11/16", 3/4", 13/16", 7/8", 15/16"
- finitura cromata satinata

RICAMBI

BGS articolo	DESCRIZIONE	Euro
BGS 2434-LEER	CASSETTA VUOTA	8,42



BGS articolo	DESCRIZIONE	Euro
BGS 2226	SET 16 PEZZI BUSSOLE POLIGONALI 8-24 MM FINITURA CROMATA SATINATA	40,04

CARATTERISTICHE

- misure: 8 - 9 - 10 - 11 - 12 - 13 - 14 - 15 - 16 - 17 - 18 - 19 - 20 - 21 - 22 - 24 mm



BGS articolo	DESCRIZIONE	Euro
BGS 2267	SET 21 PEZZI, BUSSOLE POLIGONALI ATT. 1/2", 8-36 MM	93,08

CARATTERISTICHE

- misure: 8 - 9 - 10 - 11 - 12 - 13 - 14 - 15 - 16 - 17 - 18 - 19 - 20 - 21 - 22 - 24 - 27 - 30 - 32 - 34 - 36 mm

1/2"

BUSSOLE
MULTIMPRONTA
SPLINE DRIVE

 1/2" MULTIMPRONTA
SPLINE DRIVE
 

BGS articolo	DESCRIZIONE	Euro
BGS 2152	SET 19 PEZZI BUSSOLE "MULTIMPRONTA"	66,17

CARATTERISTICHE

- lo speciale profilo "multimpronta" consente l'uso universale con misure a esagono, poligonale, Torx, metrico e pollici
- 8 - 9 - 10 - 11 - 12 - 13 - 14 - 15 - 16 - 17 - 18 - 19 - 20 - 21 - 22 - 24 - 27 - 30 - 32 mm
- anche per bussole Torx (E10, E12, E14, E16, E18, E20, E22, E24), e misure in pollici (5/16", 11/32", 3/8", 7/16", 15/32", 1/2", 9/16", 19/32"; 5/8", 3/4", 25/32", 13/16", 7/8", 15/16", 1-1/16", 1-3/16", 1-1/4")
- per bussole con esagono e poligonale

RICAMBI

BGS articolo	DESCRIZIONE	Euro
BGS 2152-LEER	CASSETTA VUOTA	12,24

 1/2"
 
 ESAGONO

**BUSSOLE CHROM-VANADIUM SATINATE
LUNGHE ESAGONO INTERNO PROFONDO**

 Attacco: 1/2"
impronta: ESAGONO

BGS articolo	mm	L mm		Euro
BGS 9355	NEW 8	77	1	6,83
BGS 10550	10	77	1	6,83
BGS 10551	11	77	1	6,83
BGS 10552	12	77	1	6,83
BGS 10553	13	77	1	6,83
BGS 10554	14	77	1	7,14
BGS 10555	15	77	1	7,14
BGS 10556	16	77	1	7,14
BGS 10557	17	77	1	7,35
BGS 10558	18	77	1	7,88
BGS 10559	19	77	1	7,88
BGS 10560	20	77	1	8,24
BGS 10561	21	77	1	8,72
BGS 10562	22	77	1	9,24
BGS 10564	24	77	1	11,03
BGS 10566	NEW 26	77	1	11,03
BGS 10567	27	77	1	11,03
BGS 10568	NEW 28	77	1	11,03
BGS 10570	NEW 30	77	1	11,73
BGS 10572	NEW 32	77	1	12,62
BGS 9846	NEW 38	77	1	17,33



 1/2"
 

 POLIGONALE

**BUSSOLE CHROM-VANADIUM POLIGONALI
LUNGHE - SATINATE**

 Attacco: 1/2"
impronta: POLIGONALI

BGS articolo	mm	L mm		Euro
BGS 9356	NEW 8	77	1	5,36
BGS 10680	10	77	1	5,10
BGS 9357	NEW 11	77	1	4,85
BGS 10662	12	77	1	4,85
BGS 10681	13	77	1	5,10
BGS 10664	14	77	1	5,10
BGS 10682	15	77	1	5,10
BGS 10683	16	77	1	5,10
BGS 10684	17	77	1	5,10
BGS 10685	18	77	1	5,61
BGS 10686	19	77	1	5,61
BGS 9359	NEW 20	77	1	6,12
BGS 9360	NEW 21	77	1	6,38
BGS 10687	22	77	1	6,89
BGS 10688	24	77	1	7,40
BGS 10663	NEW 26	77	1	8,16
BGS 9363	NEW 27	77	1	9,95
BGS 10689	NEW 28	77	1	8,93



 1/2"
 

 SURFACE
DRIVE

**BUSSOLE CHROM-VANADIUM - SATINATE
LUNGHE - SURFACE DRIVE**

 Attacco: 1/2"
impronta: SURFACE-DRIVE



BGS articolo	mm	L mm		Euro
BGS 10268	8	77	1	5,61
BGS 10270	10	77	1	5,61
BGS 10271	11	77	1	5,61
BGS 10272	12	77	1	5,61
BGS 2943	13	77	1	4,90
BGS 2944	14	77	1	4,90
BGS 2945	15	77	1	4,90
BGS 2946	16	77	1	4,90
BGS 2947	17	77	1	4,90
BGS 2948	18	77	1	5,23
BGS 2949	19	77	1	5,23
BGS 2951	21	77	1	6,38
BGS 2952	22	77	1	7,14
BGS 9361	NEW 24	77	1	7,40
BGS 9362	NEW 27	77	1	9,69
BGS 2956	NEW 28	77	1	8,93



 1/2"
 
 TORX®

TORX® LUNGHE SATINATE

 Attacco: 1/2"
impronta: TORX®

BGS articolo		L mm		Euro
BGS 6440	E 10	77	1	7,50
482-1177	E 11	77	1	8,40
BGS 6442	E 12	77	1	8,40
BGS 6444	E 14	77	1	8,65
BGS 6446	E 16	77	1	8,91
BGS 6448	E 18	77	1	9,16
BGS 6450	E 20	77	1	9,42

TORX®		S mm	S mm	
	E 4	3.70	E 16	14.60
	E 5	4.60	E 18	16.50
	E 6	5.60	E 20	18.30
	E 7	6.10	E 22	20.10
	E 8	7.40	E 24	22.00
	E 10	9.30	E 26	23.70
	E 11	9.90	E 28	25.50
	E 12	11.00	E 30	27.30
	E 14	12.80	E 32	29.00

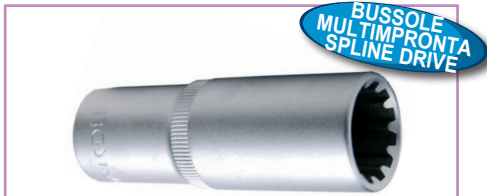

BUSSOLE
MULTIMPRONTA
SPLINE DRIVE

1/2"

MULTIMPRONTA
SPLINE DRIVE

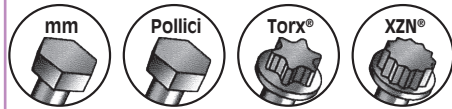

BUSSOLE CHROM-VANADIUM
MULTIMPRONTA SPLINE-DRIVE

Attacco: 1/2"
impronta: SPLINE DRIVE

BGS articolo	mm	L mm		Euro
BGS 10254	14	77	1	5,48
BGS 10255	15	77	1	5,99
BGS 10256	16	77	1	5,99
BGS 10257	17	77	1	6,12
BGS 10258	18	77	1	6,25
BGS 10259	19	77	1	6,25

MILLIMETRI
E POLLICI



PRO

CV

BUSSOLA UNIVERSALE

BGS articolo	PER MISURE		Euro
BGS 2533	3/8" 9-19 MM	1	16,58
BGS 2531	1/2" 11-30 MM	1	50,24

CARATTERISTICHE

- adatta a tutte le impronte esagonali anche in pollici



1/2"

CV

PRO+

ESAGONO

BGS articolo

DESCRIZIONE

Euro

BGS 2223 SET 9 PEZZI, BUSSOLE TIPO LUNGO

42,08

CARATTERISTICHE

- finitura satinata cromata, zigrinata
- esagonali
- misure: 10-13-15-16-17-18-19-22-24 mm



1/2"

PRO+

CV

POLIGONALE

BGS articolo

DESCRIZIONE

Euro

BGS 5253 SET 9 PEZZI, BUSSOLE TIPO LUNGO, POLIGONALI, ATT. 1/2"

44,63

CARATTERISTICHE

- misure: 10 - 13 - 15 - 16 - 17 - 18 - 19 - 22 - 24 mm
- finitura satinata cromata
- zigrinate
- con supporto in plastica

POLLICI



1/2"

ESAGONO

CV

PRO+

BGS articolo

DESCRIZIONE

Euro

BGS 2435 SET 10 PEZZI BUSSOLE TIPO LUNGO

44,63

CARATTERISTICHE

- finitura esagonale
- 3/8", 7/16", 1/2", 9/16", 5/8", 11/16", 3/4" 13/16", 7/8", 15/16"
- finitura satinata cromata



1/2"

TORX

CV

PRO+

BGS articolo

DESCRIZIONE

Euro

BGS 2026 SET 9 PEZZI, BUSSOLE TIPO LUNGO PER VITI TIPO TORX

50,86

CARATTERISTICHE

- finitura satinata cromata
- zigrinate
- Torx (lunghezza circa 80 mm) E 10 - 11 - 12 - 14 - 16 - 18 - 20 - 22 - 24



CHIAVI APERTE A ZAMPA DI GALLO

attacco: 1/2"

articolo	mm		Euro
BGS 1757-20	20	1	9,31
BGS 1757-21	21	1	10,20
BGS 1757-22	22	1	10,46
BGS 1757-23	23	1	13,52
BGS 1757-24	24	1	13,52
BGS 1757-25	25	1	13,52
BGS 1757-26	26	1	13,52
BGS 1757-27	27	1	14,03
BGS 1757-28	28	1	14,03
BGS 1757-30	30	1	15,30
BGS 1757-32	32	1	16,83
BGS 1759-33	33	1	22,44
BGS 1759-36	36	1	22,95



PRO+

SET 13 PZ CHIAVI APERTE A ZAMPA DI GALLO

- 20, 21, 22, 23, 24, 25, 26, 27, 28, 30, 32, MM
- N. 1 PROLUNGA 1/2" L. 125 MM
- N. 1 IMPUGNATURA CON QUADRO SNODATO L. 385 MM

attacco: 1/2"

articolo	Descrizione		Euro
BGS 1757	SET 13 PEZZI	1	174,88
BGS 1757-LEER	CASSETTA VUOTA PER SET BGS 1757	1	16,58



PRO+

SET 8 PZ CHIAVI APERTE A ZAMPA DI GALLO

- 33, 36 MM, ATTACCO QUADRO 1/2"
- 38, 41, 46, 50 MM, ATTACCO QUADRO 3/4"
- N. 1 PROLUNGA 1/2" L. 125 MM
- N. 1 PROLUNGA 3/4" L. 100 MM

attacco: 1/2" - 3/4"

articolo	Descrizione		Euro
BGS 1759	SET 7 CHIAVI	1	258,75



PRO+



CV

articolo	DESCRIZIONE	Euro
BGS 9156	BUSSOLA PER TIRANTI, ATTACCO 1/2"	33,02

CARATTERISTICHE

- per la rimozione delle estremità dei tiranti
- per la maggior parte delle auto e alcuni camion
- dimensioni:
 - apertura: 18,5 x 34 mm
 - Ø interno: 49 mm
 - lunghezza: 57,5 mm
 - profondità: 40 mm



ESAGONO

CHIAVI A BUSSOLA MASCHIO ESAGONALI

Attacco: 1/2"

impronta: ESAGONO

articolo	mm	L mm		Euro
BGS 4250	4	55	1	7,35
BGS 4251	5	55	1	7,35
BGS 9467	NEW 5,5	55	1	7,35
BGS 4252	6	55	1	7,35
BGS 4253	7	55	1	7,35
BGS 4254	8	55	1	7,35
BGS 4340	9	55	1	7,35
BGS 4255	10	55	1	7,88
BGS 4256	12	55	1	7,88
455-1355	13	55	1	8,19
BGS 4257	14	55	1	8,19
BGS 5184-H17	17	55	1	8,19
BGS 5184-H19	19	55	1	10,50
BGS 5184-H22	22	55	1	12,08
BGS 5184-H24	24	55	1	13,13
BGS 5052-14	NEW 14	70	1	8,19
BGS 5052-16	NEW 16	70	1	8,19
BGS 5052-17	NEW 17	70	1	8,19
BGS 5052-18	NEW 18	70	1	10,50
BGS 5052-19	NEW 19	70	1	10,50
BGS 4295	NEW 22	70	1	12,08
BGS 4270	5	100	1	8,30
BGS 4271	6	100	1	8,30
BGS 4217	7	100	1	8,30
BGS 4272	8	100	1	8,30
BGS 5184-H10	10	100	1	8,30
BGS 5184-H11	11	100	1	8,30
BGS 4273	12	100	1	8,93
BGS 5184-H13	13	100	1	9,45
BGS 4296	NEW 14	100	1	9,45
458-0514	5	140	1	10,50
458-0614	6	140	1	10,50
458-0714	7	140	1	10,50
458-0814	8	140	1	10,50
458-1014	10	140	1	10,50
458-1114	11	140	1	10,50
458-1214	12	140	1	11,55
458-1314	13	140	1	11,55
BGS 4274	14	140	1	11,55
BGS 4275	5	200	1	13,65
BGS 4276	6	200	1	13,65
BGS 4277	7	200	1	13,65
BGS 4278	8	200	1	13,65
BGS 4279	10	200	1	13,65
BGS 4280	12	200	1	13,65
BGS 4215	5	240	1	15,75
BGS 4216	6	240	1	15,75
BGS 5184-H7	7	240	1	15,75
BGS 4218	8	240	1	15,75



 1/2"  **ESAGONO**

CHIAVI A BUSSOLA MASCHIO ESAGONALI TESTA SFERICA

Attacco: 1/2"
impronta: ESAGONO

articolo	mm	L mm		Euro
459-0510	5	100	1	11,55
459-0610	6	100	1	11,55
459-0810	8	100	1	11,55
459-1010	10	100	1	11,55
BGS 4258-5	5	140	1	12,60
BGS 4258-6	6	140	1	12,60
NEW BGS 4258-7	7	140	1	12,60
BGS 4258-8	8	140	1	12,60
BGS 4258-10	10	140	1	12,60
BGS 4258-12	12	140	1	12,60
BGS 5184-HB5	5	160	1	15,75



NEW

 1/2"  22 mm  **TORX®**



articolo	DESCRIZIONE	Euro
BGS 9532	BUSSOLA PER CINGHIE A V, ATT. 1/2", TORX TX60	14,56

CARATTERISTICHE

- bussola speciale per motori TDI common rail VAG 6 cilindri per il rilascio della cinghia a V
- per uso come OEM T40087
- manovra:
 - quadro femmina: 1/2"
 - esagono: 22 mm



TORX®		S mm	S mm
T 6	1.70	T 40	6.70
T 7	2.00	T 45	7.90
T 8	2.30	T 50	8.90
T 9	2.50	T 55	11.30
T 10	2.70	T 60	13.30
T 15	3.30	T 70	15.60
T 20	3.90	T 80	17.60
T 25	4.50	T 90	20.00
T 27	5.00	T 100	22.20
T 30	5.60		



 1/2"  **TORX®**

CHIAVI A BUSSOLA TORX®

Attacco: 1/2"
impronta: TORX®

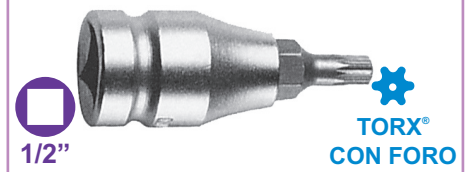

articolo		L mm		Euro
BGS 4368	NEW TX 15	55	1	8,40
BGS 4369	TX 20	55	1	8,40
BGS 4370	TX 25	55	1	8,40
BGS 4367	TX 27	55	1	8,40
BGS 4371	TX 30	55	1	8,40
BGS 9627	NEW TX 35	55	1	8,40
BGS 4372	TX 40	55	1	8,93
BGS 4373	TX 45	55	1	8,93
BGS 4374	TX 50	55	1	8,93
BGS 4375	TX 55	55	1	9,98
BGS 4378	TX 60	55	1	10,50
BGS 4379	TX 70	55	1	13,65
BGS 4468	NEW TX 15	100	1	8,40
BGS 4469	TX 20	100	1	8,93
BGS 4470	TX 25	100	1	8,93
BGS 4467	TX 27	100	1	8,93
BGS 4471	TX 30	100	1	8,93
BGS 9628	NEW TX 35	100	1	8,93
BGS 4472	TX 40	100	1	9,45
BGS 4473	TX 45	100	1	9,45
BGS 4474	TX 50	100	1	9,45
BGS 4475	TX 55	100	1	11,55
BGS 4476	TX 60	100	1	11,55
BGS 4477	TX 70	100	1	16,80
4705-8010	TX 80	100	1	21,00
4705-9010	TX 90	100	1	30,45
4705-10010	TX 100	100	1	37,80
BGS 9364	NEW TX 25	140	1	12,60
BGS 9348	NEW TX 27	140	1	12,60
BGS 5184-T40	TX 40	140	1	12,60
BGS 5184-T45	TX 45	140	1	12,60
BGS 5184-T50	TX 50	140	1	12,60
BGS 5184-T55	TX 55	140	1	13,65
BGS 5184-T60	TX 60	140	1	13,65
BGS 5184-T70	TX 70	140	1	16,80
471-8014	TX 80	140	1	23,10
471-9014	TX 90	140	1	33,60
471-10014	TX 100	140	1	38,85
BGS 9365	NEW TX 25	200	1	15,75
471-3020	TX 30	200	1	15,75
BGS 4480	TX 40	200	1	15,75
BGS 4481	TX 45	200	1	15,75
BGS 4482	TX 50	200	1	15,75
BGS 4483	TX 55	200	1	16,80
BGS 4484	TX 60	200	1	16,80
BGS 4485	TX 70	200	1	19,95



 1/2"  **TORX® CON FORO**

CHIAVI A BUSSOLA TORX® C/FORO

Attacco: 1/2"
impronta: TORX® C/FORO

articolo		L mm		Euro
472-2055	TH 20	55	1	10,50
472-2555	TH 25	55	1	10,50
472-2755	TH 27	55	1	10,50
472-3055	TH 30	55	1	10,50
BGS 4326	TH 40	55	1	11,55
BGS 4327	TH 45	55	1	11,55
BGS 4328	TH 50	55	1	11,55
BGS 4329	TH 55	55	1	13,65
BGS 4376	TH 60	55	1	13,65
BGS 4377	TH 70	55	1	13,65
473-2010	TH 20	100	1	11,55
473-2510	TH 25	100	1	11,55
473-2710	TH 27	100	1	11,55
473-3010	TH 30	100	1	11,55
473-4010	TH 40	100	1	12,60
473-4510	TH 45	100	1	12,60
473-5010	TH 50	100	1	12,60
473-5510	TH 55	100	1	14,70
473-6010	TH 60	100	1	14,70
473-7010	TH 70	100	1	16,80
BGS 5184-TB80	TH 80	100	1	23,10
473-9010	TH 90	100	1	31,50
473-10010	TH 100	100	1	37,80
NEW BGS 5103-TB70	TH 70	110	1	16,80
NEW BGS 5103-TB80	TH 80	110	1	23,10
NEW BGS 5103-TB90	TH 90	110	1	31,50
NEW BGS 5103-TB100	TH 100	110	1	37,80
474-4014	TH 40	140	1	13,65
474-4514	TH 45	140	1	13,65
474-5014	TH 50	140	1	13,65
474-5514	TH 55	140	1	14,70
474-6014	TH 60	140	1	14,70
474-7014	TH 70	140	1	16,80
474-8014	TH 80	140	1	25,20
474-9014	TH 90	140	1	34,65
474-10014	TH 100	140	1	39,90
4742-4020	TH 40	200	1	21,00
4742-4520	TH 45	200	1	22,05
4742-5020	TH 50	200	1	25,20
BGS 5184-TB30	TH 30	300	1	27,30

1/2"

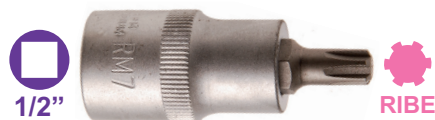
CHIAVI A BUSSOLA RIBE®

 Attacco: 1/2"
 impronta: RIBE®

FEFMEC articolo			L mm		Euro
BGS 4150	NEW	M 5	55	1	9,45
BGS 4151	NEW	M 6	55	1	9,45
BGS 4152	NEW	M 7	55	1	9,45
BGS 4153	NEW	M 8	55	1	9,45
BGS 4154	NEW	M 9	55	1	9,45
BGS 4155	NEW	M 10	55	1	9,45
BGS 9353	NEW	M 10.3	55	1	9,00
BGS 4156	NEW	M 12	55	1	10,50
BGS 4157	NEW	M 13	55	1	10,50
BGS 4158	NEW	M 14	55	1	10,50

4782-0005		M 5	63	1	9,45
4782-0006		M 6	63	1	9,45
4782-0007		M 7	63	1	9,45
4782-0008		M 8	63	1	9,45
4782-0009		M 9	63	1	9,45
4782-0010		M 10	63	1	9,45
4782-0012		M 12	63	1	10,50
4782-0013		M 13	63	1	10,50
4782-0014		M 14	63	1	10,50
4782-0016		M 16	63	1	11,55
4782-0018		M 18	63	1	15,75
4782-0020		M 20	63	1	16,80

BGS 4160		M 5	100	1	10,50
BGS 4161		M 6	100	1	10,50
BGS 4162		M 7	100	1	10,50
BGS 4163		M 8	100	1	10,50
BGS 5184-R9		M 9	100	1	10,50
BGS 4165		M 10	100	1	10,50
BGS 4166		M 12	100	1	11,55
BGS 4167		M 13	100	1	11,55
BGS 4168		M 14	100	1	13,65
4784-0016		M 16	100	1	15,75

BGS 4234		M 7	140	1	17,85
BGS 4173		M 8	140	1	17,85
BGS 4174		M 9	140	1	17,85
BGS 5184-R10		M 10	140	1	17,85
BGS 4179	NEW	M 10.3	140	1	17,85
BGS 4176		M 12	140	1	19,95
BGS 4177		M 13	140	1	23,10
BGS 4178		M 14	140	1	24,15

4788-0007		M 7	200	1	22,05
BGS 4183		M 8	200	1	22,05
BGS 4184		M 9	200	1	22,05
BGS 4189		M 10	200	1	22,05
BGS 4185	NEW	M 10.3	200	1	22,05
BGS 4186		M 12	200	1	25,20
BGS 4187		M 13	200	1	25,20
BGS 4188		M 14	200	1	25,20

BGS 5184-R7		M 7	240	1	27,30
BGS 5184-R8		M 8	240	1	27,30

RIBE	S mm	W mm
M 5	5.00	1.20
M 6	6.00	1.30
M 7	7.00	1.40
M 8	8.00	1.80
M 9	9.00	2.00
M 10	10.00	2.30
M 12	12.00	2.60
M 13	13.00	3.10
M 14	14.00	3.20
M 16	16.00	3.60

CHIAVI A BUSSOLA RIBE® C/FORO

 Attacco: 1/2"
 impronta: RIBE® C/FORO

FEFMEC articolo		L mm		Euro
4783-0005	M 5	63	1	11,55
4783-0006	M 6	63	1	11,55
4783-0007	M 7	63	1	11,55
4783-0008	M 8	63	1	11,55
4783-0009	M 9	63	1	11,55
4783-0010	M 10	63	1	11,55
4783-0012	M 12	63	1	11,55
4783-0013	M 13	63	1	11,55
4783-0014	M 14	63	1	12,60
4783-0016	M 16	63	1	13,65

4785-0005	M 5	100	1	12,60
4785-0006	M 6	100	1	12,60
4785-0007	M 7	100	1	12,60
4785-0008	M 8	100	1	12,60
4785-0009	M 9	100	1	12,60
4785-0010	M 10	100	1	12,60
4785-0012	M 12	100	1	13,65
4785-0013	M 13	100	1	13,65
4785-0014	M 14	100	1	14,70
4785-0016	M 16	100	1	16,80

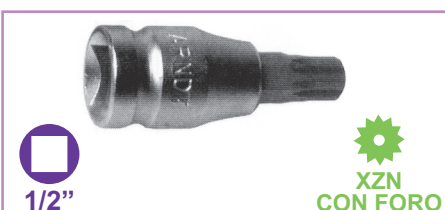
CHIAVI A BUSSOLA XZN®

 Attacco: 1/2"
 impronta: XZN®

FEFMEC articolo		L mm		Euro
4751-1455	M 14	55	1	13,65
BGS 4356	M 16	55	1	13,65
BGS 4357	M 16	100	1	16,80
BGS 4365	M 18	100	1	17,85

CHIAVI A BUSSOLA XZN®

 Attacco: 1/2"
 impronta: XZN®

FEFMEC articolo		L mm		Euro
BGS 4350	M 5	55	1	9,45
BGS 4351	M 6	55	1	9,45
BGS 4355	M 7	55	1	9,45
BGS 4352	M 8	55	1	9,45
BGS 4349	M 9	55	1	9,45
BGS 4353	M 10	55	1	9,45
BGS 4354	M 12	55	1	10,50
BGS 4344	M 14	55	1	10,50
BGS 4346	M 16	55	1	11,55
BGS 5180-M17	M 17	55	1	12,60
BGS 4347	M 18	55	1	11,55

BGS 4359	M 5	100	1	10,50
BGS 4360	M 6	100	1	10,50
476-0710	M 7	100	1	10,50
BGS 4361	M 8	100	1	10,50
BGS 5184-M9	M 9	100	1	11,55
BGS 4362	M 10	100	1	11,55
BGS 4363	M 12	100	1	13,65
BGS 4364	M 14	100	1	15,75
476-1610	M 16	100	1	15,75
BGS 5184-M18	M 18	78	1	12,00

BGS 4330	M 5	140	1	11,55
BGS 4331	M 6	140	1	11,55
BGS 4432	M 7	140	1	11,55
BGS 4332	M 8	140	1	11,55
BGS 4333	M 9	140	1	11,55
BGS 5184-M10	M 10	140	1	12,60
BGS 5184-M12	M 12	140	1	13,65
BGS 5184-M14	M 14	140	1	14,70

BGS 4334	M 8	200	1	15,75
BGS 4335	M 10	200	1	15,75
BGS 4336	M 12	200	1	15,75
BGS 4337	M 14	200	1	15,75

BGS 4227	M 8	800	1	32,55
BGS 4228	M 10	800	1	33,60
BGS 4229	M 12	800	1	34,65
BGS 4233	M 14	800	1	35,70

XZN	S mm	S mm	
M 4	3,60	M12	11,50
M 5	4,80	M14	13,30
M 6	6,10	M16	15,70
M 8	7,30	M18	16,90
M10	9,70		



ESAGONO TORX[®] XZN ESAGONO

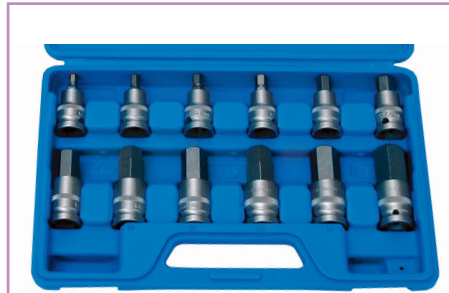

1/2" ESAGONO

CASSETTA CHIAVI A BUSSOLA MASCHIO ESAGONALI
• 5-6-7-8-10-12-14-16-17-18-19-22 MM
L. 60/70 MM

FEWEC articolo	Descrizione	Quantità	Euro
50522	CASSETTA 12 PEZZI	1	83,48

POLLICI



1/2" ESAGONO

CASSETTA CHIAVI A BUSSOLA MASCHIO ESAGONALI BRUGOLA IN POLLICI
• 5/32"-3/16"-7/32"-1/4"-5/16"-3/8"-7/16"-1/2"-9/16" - LUNGH. 55 MM

FEWEC articolo	pollici	L mm	Quantità	Euro
40902-5/32	5/32"	55	1	12,08
40902-3/16	3/16"	55	1	12,08
40902-7/32	7/32"	55	1	12,60
40902-1/4	1/4"	55	1	12,60
40902-5/16	5/16"	55	1	13,13
40902-3/8	3/8"	55	1	13,65
40902-7/16	7/16"	55	1	14,28
40902-1/2	1/2"	55	1	15,54
40902-9/16	9/16"	55	1	16,80
40902	CASSETTA 9 PEZZI		1	84,00

POLLICI

NEW



1/2" ESAGONO PRO+ CV

BGS articolo	DESCRIZIONE	Euro
BGS 5053	SET 12 PEZZI, CHIAVI A BUSSOLA ESAGONALI IN POLLICI, 7/32" - 3/4"	71,15

CARATTERISTICHE

- comprende:
 - bussole lunghezza 55 mm: 7/32" - 1/4" - 9/32" - 5/16" - 3/8" - 15/32"
 - bussole lunghezza 70 mm: 9/16" - 5/8" - 11/16" - 13/16" - 3/4"
- finitura satinata cromata
- zigrinate

BGS articolo	DESCRIZIONE	Euro
BGS 4095	ESPOSITORE 315 PEZZI, PER LA VENDITA, CON DOTAZIONE COMPLETA DI BUSSOLE & CHIAVI A BUSSOLA	1025,00

CARATTERISTICHE

- set 315 pezzi bussole e chiavi a bussola att. 1/2"
- finitura cromata satinata, zigrinate
- chiavi a bussola con esagono maschio, lungh. 100 mm (7 pz. per ciascun formato): 7 - 8 - 10 - 12 mm
- chiavi a bussola XZN maschio, lungh. 100 mm (7 pz. per ciascun formato): M8 - M10 - M12 - M14
- chiavi a bussola Torx maschio, lungh. 100 mm (7 pz. per ciascun formato): TX25 - TX30 - TX40 - TX45 - TX50
- bussole esagonali (pezzi per ciascuna misura): 8 mm (10 pz.), 9 mm (10 pz.), 10 mm (20 pz.), 11 mm (10 pz.), 12 mm (10 pz.), 13 mm (20 pz.), 14 mm (10 pz.), 15 mm (10 pz.), 16 mm (10 pz.), 17 mm (20 pz.), 18 mm (8 pz.), 19 mm (20 pz.), 21 mm (15 pz.), 22 mm (15 pz.), 24 mm (10 pz.), 27 mm (8 pz.), 30 mm (8 pz.), 32 mm (10 pz.)
- dimensioni dell'espositore: (prof. x largh. x altezza pz.) 335 x 410 x 270 mm

RICAMBI

BGS articolo	DESCRIZIONE	Euro
BGS 4095-2	ESPOSITORE VUOTO	287,50





ESAGONO



PRO+



BGS articolo	DESCRIZIONE	Euro
BGS 4258	SET 6 PEZZI CHIAVI A BUSSOLA ESAGONALI TESTA SFERICA	45,77

CARATTERISTICHE

- misure: 5-6-7-8-10-12 mm
- lunghezza 140 mm

RICAMBI

BGS articolo	descrizione	Euro
BGS 4258-5	BUSSOLA 5 MM	12,60
BGS 4258-6	BUSSOLA 6 MM	12,60
BGS 4258-7	BUSSOLA 7 MM	12,60
BGS 4258-8	BUSSOLA 8 MM	12,60
BGS 4258-10	BUSSOLA 10 MM	12,60
BGS 4258-12	BUSSOLA 12 MM	12,60

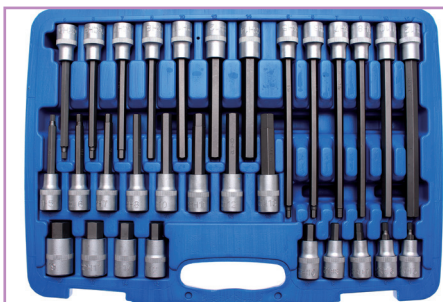

ESAGONO

PRO+



BGS articolo	DESCRIZIONE	Euro
BGS 5181	SET 30 PEZZI CHIAVI A BUSSOLA ESAGONALI ASSORTITE	154,88

CARATTERISTICHE

- inserti corti acciaio S2
- comprende:
 - lunghezza 55 mm: 5-6-7-8-10-12-14-17-19 mm
 - lunghezza 100 mm: 5-6-7-8-10-11-12-13 mm
 - lunghezza 140 mm: 5-6-7-8-10-12-14 mm
 - lunghezza 200 mm: 5-6-7-8-10-12 mm

RICAMBI

BGS articolo	DESCRIZIONE	Euro
BGS 5181-LEER	CASSETTA VUOTA	24,74



PRO+



ESAGONO

BGS articolo	DESCRIZIONE	Euro
BGS 8887	SERIE 6 PEZZI, BUSSOLE ATTACCO QUADRO 1/2", ESAGONO MASCHIO 6-14 MM	24,23

CARATTERISTICHE

- misure: 6 - 7 - 8 - 10 - 12 - 14 mm
- attacco quadro 1/2"
- ziggrinate
- finitura cromata satinata



-3/8" -1/2"

ESAGONO



CV

PRO+

BGS articolo	DESCRIZIONE	Euro
BGS 5099	SET 10 PEZZI, CHIAVI A BUSSOLA ESAGONALI EXTRA CORTE, 4 - 19 MM	30,60

CARATTERISTICHE

- attacco 1/4", lunghezza 30 mm: 4 - 5 - 6 - 7 - 8 mm
- attacco 3/8", lunghezza 38 mm: 10 - 12 - 14 mm
- attacco 1/2", lunghezza 48 mm: 17 - 19 mm
- ziggrinate
- finitura cromata satinata
- su guida metallica

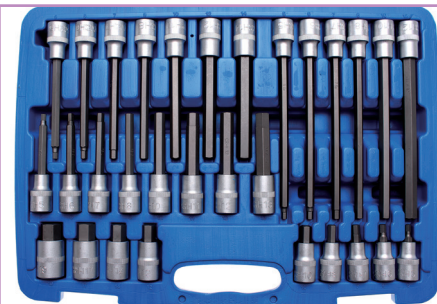

TORX®

PRO+



BGS articolo	DESCRIZIONE	Euro
BGS 5182	SET 32 PEZZI, CHIAVI A BUSSOLA TORX ASSORTITE	162,38

CARATTERISTICHE

- inserti corti acciaio S2
- comprende:
 - lunghezza 55 mm: TX20-TX25-TX27-TX30-TX40 TX45-TX50-TX55-TX60-TX70
 - lunghezza 100 mm: TX20-TX25-TX27-TX30-TX40 TX45-TX50-TX55-TX60-TX70
 - lunghezza 140 mm: TX40-TX45-TX50-TX55-TX60-TX70
 - lunghezza 200 mm: TX40-TX45-TX50-TX55-TX60-TX70



TORX® TORX®

- 9 BUSSOLE TORX® FEMMINA
- E 10-11-12-14-16-18-20-22-24
- 10 BUSSOLE CON INSERTI TORX®
- T 20-25-27-30-40-45-50-55-60-70

 attacco: 1/2"
 impronta: TORX®

BGS articolo	Descrizione	Euro
54019	CASSETTA PLASTICA 19 PEZZI	57,75



BGS articolo	DESCRIZIONE	Euro
BGS 95100	SET 19 PEZZI, BUSSOLE TORX FEMMINA E BUSSOLE CON INSERTI TORX	41,34

CARATTERISTICHE

- comprende le seguenti bussole Torx femmina: E10, E11, E12, E14, E16, E18, E20, E22, E24
- comprende le seguenti bussole con inserti Torx: TX20, TX25, TX27, TX30, TX40, TX45, TX50, TX55, TX60, TX70
- finitura cromata satinata



BGS articolo	DESCRIZIONE	Euro
BGS 5098	SET 12 PEZZI, CHIAVI A BUSSOLA TORX® EXTRA CORTE, T8 - T60	28,05

CARATTERISTICHE

- attacco 1/4", lunghezza 30 mm: T8 - T10 - T15 - T20 - T25 - T27
- attacco 3/8", lunghezza 38 mm : T30 - T40 - T45 - T50 - T55
- attacco 1/2", lunghezza 48 mm: T60
- zigrinate
- finitura cromata satinata
- su guida metallica

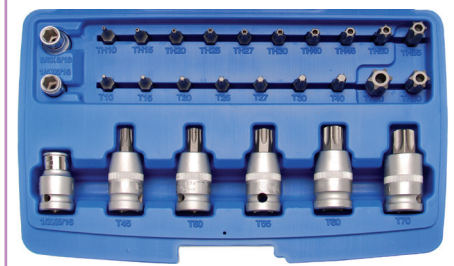

BGS articolo	DESCRIZIONE	Euro
BGS 5101	SET 27 PEZZI, INSERTI E CHIAVI A BUSSOLA TORX	55,46

CARATTERISTICHE

- durezza e coppia in conformità con le norme tedesche DIN
- 5 chiavi a bussola attacco da 1/2": T45-50-55-60-70
- 7 inserti per viti Torx: T10-15-20-25-27-30-40
- 12 inserti per viti Torx c/foro: T10-15-20-25-27-30-40-45-50-55-60-70
- 3 adattatori per inserti attacco da 1/4" - 3/8" - 1/2"



BGS articolo	DESCRIZIONE	Euro
BGS 8886	SERIE 6 PEZZI, BUSSOLE ATTACCO QUADRO 1/2", TORX TX40-TX55	16,58

CARATTERISTICHE

- misure: Tx40 - Tx45 - Tx50 - Tx55
- attacco quadro 1/2"
- zigrinate
- finitura cromata satinata



CASSETTA CHIAVI A BUSSOLA TORX® CON FORO

- N. 10 T20, T25, T27, T30, T40, T45, T50, T55, T60, T70 - L. 55 MM
- N. 10 T20, T25, T27, T30, T40, T45, T50, T55, T60, T70 - L. 100 MM
- N. 6 T40, T45, T50, T55, T60, T70 L. 140 MM
- N. 6 T40, T45, T50, T55, T60, T70 L. 200 MM

attacco: 1/2"
impronta: TORX® CON FORO

BGS articolo	Descrizione	Euro
4203	CASSETTA PLASTICA 32 PEZZI	136,50



BGS articolo	DESCRIZIONE	Euro
BGS 8885	SERIE 6 PEZZI, BUSSOLE ATTACCO QUADRO 1/2", TORX CON FORO TH40-TH55	16,58

CARATTERISTICHE

- misure: Th40 - Th45 - Th50 - Th55
- attacco quadro 1/2"
- zigrinate
- finitura cromata satinata

TORX®	S mm	S mm	
T 6	1.70	T 40	6.70
T 7	2.00	T 45	7.90
T 8	2.30	T 50	8.90
T 9	2.50	T 55	11.30
T 10	2.70	T 60	13.30
T 15	3.30	T 70	15.60
T 20	3.90	T 80	17.60
T 25	4.50	T 90	20.00
T 27	5.00	T 100	22.20
T 30	5.60		

1/2"



TORX®
1/2" CON FORO

PRO+

CV

BSG articolo	DESCRIZIONE	Euro
BGS 5103	SET 4 PEZZI, CHIAVI A BUSSOLA TORX C/FORO	45,14

CARATTERISTICHE

- TH70 (testa cilindri di molte marche, vasca filtro olio)
- TH80 (assemblaggio braccio tergicristalli, MAN, serie M)
- TH90 (bulloni per testata cilindri)
- TH100 (leva dello sterzo, MAN, serie F)
- idonee per l'assemblaggio di bulloni per testata cilindri di Ford, BMW, Citroen, Renault, Audi, Mercedes)

RICAMBI

BSG articolo	DESCRIZIONE	Euro
BGS 5103-TB70	TH 70	16,80
BGS 5103-TB80	TH 80	23,10
BGS 5103-TB90	TH 90	31,50
BGS 5103-TB100	TH 100	37,80
BGS 5103-LEER	CASSETTA VUOTA	8,67



PRO+

BGS 2020



BSG articolo	DESCRIZIONE	Euro
BGS 2028	SET 6 PEZZI BUSSOLE TIPO TORX EXTRA LUNGO	90,53

CARATTERISTICHE

- E 10 - 12 - 14 - 16 - 18 - 20
- lunghezza: 140 mm
- con sfera di bloccaggio

RICAMBI

BSG articolo	DESCRIZIONE	Euro
BGS 2020	BUSSOLA E12X150 MM PER TESTATE BMW	13,26



1/2"



PRO+

BSG articolo	DESCRIZIONE	Euro
BGS 1112	SET 3 PEZZI, BUSSOLE PENTAGONALI, ATTACCO 1/2"	19,13

CARATTERISTICHE

- acciaio al cromo vanadio
- bussola pentagonale da 14 mm idonea per Opel / Vauxhall (Astra G, Zafira), Smart
- bussola speciale per freni Girling
- bussola pentagonale da 19 mm idonea per Peugeot, Renault

PENTALOBATA

	S mm	S mm
8 PR	2.20	27 PR 4.70
9 PR	2.40	30 PR 5.20
10 PR	2.60	40 PR 6.30
15 PR	3.10	45 PR 7.40
20 PR	3.60	50 PR 8.40
25 PR	4.10	55 PR 10.60



1/2"



PRO+

CV S2

BSG articolo	DESCRIZIONE	Euro
BGS 5190	SET 32 PEZZI, BUSSOLE ATT. 1/2", TORX PLUS	188,75

CARATTERISTICHE

- zigrinate
- per Torx Plus
- comprende:
 - lunghezza 55 mm: TS20, TS25, TS27, TS30, TS40, TS45, TS50, TS55, TS60, TS70
 - lunghezza 100 mm: TS20, TS25, TS27, TS30, TS40, TS45, TS50, TS55, TS60, TS70
 - lunghezza 140 mm: TS40, TS45, TS50, TS55, TS60, TS70
 - lunghezza 200 mm: TS40, TS45, TS50, TS55, TS60, TS70



1/2"



PENTALOBATA CON FORO

PRO+

CV S2



BSG articolo	DESCRIZIONE	Euro
BGS 5191	SET 32 PEZZI, BUSSOLE ATT. 1/2", 5 PUNTE CON FORO	206,25

CARATTERISTICHE

- zigrinate
- per 5 punte con foro
- comprende:
 - lunghezza 55 mm: TP20, TP25, TP27, TP30, TP40, TP45, TP50, TP55, TP60, TP70
 - lunghezza 100 mm: TP20, TP25, TP27, TP30, TP40, TP45, TP50, TP55, TP60, TP70
 - lunghezza 140 mm: TP40, TP45, TP50, TP55, TP60, TP70
 - lunghezza 200 mm: TP40, TP45, TP50, TP55, TP60, TP70



RIBE XZN TORX® TORX®

1/2"  **PRO+** 

BGS articolo	DESCRIZIONE	Euro
BGS 5014	SET 9 PEZZI, CHIAVI A BUSSOLA SPECIALI PER TESTATE CILINDRI	105,83

CARATTERISTICHE

- inserti con finitura nera

RICAMBI

BGS articolo	DESCRIZIONE	Euro
BGS 5003	TORX 70 X 120 MM	9,44
BGS 5007	RIBE 13 X 120 MM	8,93
BGS 5009	XZN 10 X 140 MM	7,40
BGS 5010	RIBE 12 X 120 MM	7,65

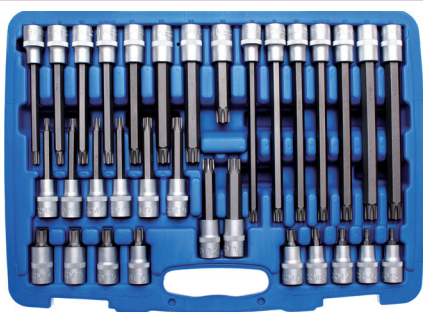

1/2"   **PRO+** 

BGS articolo	DESCRIZIONE	Euro
BGS 5183	SET 32 PEZZI, CHIAVI A BUSSOLA RIBE ASSORTITE	169,88

CARATTERISTICHE

- inserti corti acciaio S2
- comprende:
 - lunghezza 55 mm: M 5-6-7-8-9-10-12-13-14
 - lunghezza 100 mm: M 5-6-7-8-9-10-12-13-14
 - lunghezza 140 mm: M 8-9-10-10.3-12-13-14
 - lunghezza 200 mm: M 8-9-10-10.3-12-13-14



3/8"  1/2"   **PRO+** 

BGS articolo	DESCRIZIONE	Euro
BGS 5185	SET 7 PEZZI, CHIAVI A BUSSOLA RIBE MASCHIO	33,02

CARATTERISTICHE

- RIBE: M6, M7, M8, M10 con attacco 3/8"
- RIBE: M12, M13, M14 con attacco 1/2"
- in acciaio al cromo vanadio
- satinato, zigrinate
- lunghezza: 75 mm
- su guida

RIBE	S mm	W mm
M 5	5.00	1.20
M 6	6.00	1.30
M 7	7.00	1.40
M 8	8.00	1.80
M 9	9.00	2.00
M 10	10.00	2.30
M 12	12.00	2.60
M 13	13.00	3.10
M 14	14.00	3.20
M 16	16.00	3.60

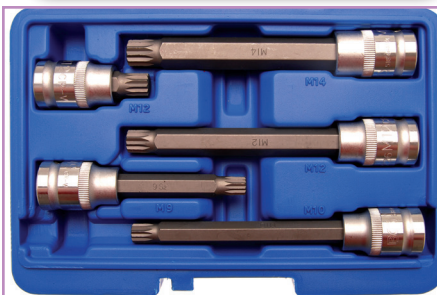

1/2"  **PRO+**  

BGS articolo	DESCRIZIONE	Euro
BGS 8449	SET 5 PEZZI, BUSSOLE MASCHIO XZN	42,08

CARATTERISTICHE

- inserti corti acciaio S2
- comprende
 - M 12 x 55 mm
 - M 9 x 100 mm
 - M 10 x 140 mm
 - M 12 x 140 mm
 - M 14 x 140 mm

PROMO

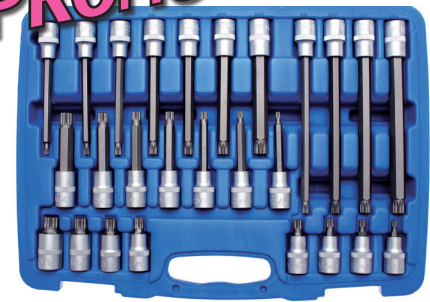

1/2"   **PRO+** 

BGS articolo	DESCRIZIONE	Euro
BGS 5180	SET 26 PEZZI, CHIAVI A BUSSOLA XZN ASSORTITE	144,88

CARATTERISTICHE

- inserti corti acciaio S2
- comprende:
 - lunghezza 55 mm: M 5-6-8-9-10-12-14-16
 - lunghezza 100 mm: M 5-6-8-9-10-12-14
 - lunghezza 140 mm: M 5-6-8-9-10-12-14
 - lunghezza 200 mm: M 8-10-12-14

XXL



1/2"   **PRO+** 

BGS articolo	DESCRIZIONE	Euro
BGS 4224	SET 3 PEZZI, BUSSOLE CON INSERTO PER ALBERO MOTORE DA 1/2", 800 MM	117,17

CARATTERISTICHE

- idoneo per viti albero motore
- non vi è necessità di barre di prolunga
- idoneo per VW e altre marche
- M8 x 800 mm, M10 e M12 x 800 mm

XZN	S mm	S mm	
M 4	3,60	M12	11,50
M 5	4,80	M14	13,30
M 6	6,10	M16	15,70
M 8	7,30	M18	16,90
M10	9,70		

DISPONIBILI
 TUTTI I RICAMBI

1/4"-3/8"-1/2"

CV
PRO+
BGS
 articolo

DESCRIZIONE
Euro
BGS 5105
**SET 8 PEZZI, BUSSOLE
 XZN**
21,17
CARATTERISTICHE

- comprende:
 - attacco 1/4": M4-M5-M6
 - attacco 3/8": M8-10-12
 - attacco 1/2": M-14-16
- finitura cromata satinata
- su guida metallica



TORX®
CON FORO TORX®

TORX®

ESAGONO

XZN

1/2"
PRO+
CV
BGS
 articolo

DESCRIZIONE
Euro
BGS 5188
**SET CHIAVI A BUSSOLA
 ATT. 1/2"**
167,38
CARATTERISTICHE

- comprende i seguenti utensili attacco 1/2":
 - chiavi a bussola Torx maschio, lungh. 55 mm: TX20-TX25-TX27-TX30-TX40-TX45-TX50-TX55-TX60-TX70
 - chiavi a bussola Torx maschio, lungh. 100 mm: TX25 - TX30 - TX40 - TX45 - TX50 - TX60
 - chiavi a bussola Esagono maschio, lungh. 55 mm: 5 - 6 - 7 - 8 - 10 - 12 - 14 - 17 - 19 mm
 - chiavi a bussola Esagono maschio, lungh. 100 mm: 6 - 7 - 8 - 10 - 12 mm
 - chiavi a bussola XZN maschio, lungh. 55 mm: M5 - M6 - M8 - M10
 - chiavi a bussola XZN maschio, lungh. 100 mm: M6 - M8 - M10 - M12 - M14
 - inserti Torx con foro, lungh. 30 mm: TH20 - TH25 - TH27 - TH30 - TH40 - TH45 - TH50 - TH55 - TH60
 - bussola portainseriti att. 1/2"

Set che comprende:

- 1 Cassetta chiavi a bussola Esagonali

ESAGONO

- 1 cassetta chiavi a bussola Torx

TORX®

- 1 Cassetta chiavi a bussola XZN



XZN

1/2"

CV
BGS
 articolo

DESCRIZIONE
Euro
BGS 5186
**SET 88 PEZZI,
 CHIAVI A BUSSOLA
 ESAGONALI, TORX E
 XZN**
324,88
CARATTERISTICHE

- cassetta chiavi a bussola Esagonali:
 - lunghezza 55 mm: 5-6-7-8-10-12-14-17-19 mm
 - lunghezza 100 mm: 5-6-7-8-10-11-12-13 mm
 - lunghezza 140 mm: 5-6-7-8-10-12-14 mm
 - lunghezza 200 mm: 5-6-7-8-10-12 mm
- cassetta chiavi a bussola Torx:
 - lunghezza 55 mm TX: 20-25-27-30-40-45-50-55-60-70
 - lunghezza 100 mm TX: 20-25-27-30-40-45-50-55-60-70
 - lunghezza 140 mm TX: 40-45-50-55-60-70
 - lunghezza 200 mm TX: 40-45-50-55-60-70
- cassetta chiavi a bussola XZN:
 - lungh. 55 mm: M5-M6-M8-M9-M10-M12-M14-M16
 - lunghezza 100 mm: M5-M6-M8-M9- M10-M12-M14
 - lunghezza 140 mm: M5-M6-M8-M9- M10-M12-M14
 - lunghezza 200 mm: M8-M10-M12-M14

1/2"

TORX®

TORX®

RIBE®
**CASSETTA CHIAVI A BUSSOLA M/F TORX®
 E RIBE®**

- N. 9 BUSSOLE TORX® FEMMINA E 10-11-12-14-16-18-20-22-24
- N. 18 CHIAVI A BUSSOLA RIBE® M 5-6-7-8-9-10-12-13-14 L. 55
- M 5-6-7-8-9-10-12-13-14 L. 100
- N. 10 CHIAVI A BUSSOLA TORX® MASCHIO T 20-25-27-30-40-45-50-55-60-70 L. 55

attacco: 1/2"

impronta: RIBE® - TORX®

BGS
 articolo

Descrizione

Euro
3704
**CASSETTA PLASTICA
 37 PEZZI**
1
136,50



1/4" 3/8" 1/2"

FEFMEC articolo	DESCRIZIONE	Euro
483814	SET 3 PEZZI, ADATTATORI DOPPIO QUADRO	12,60

CARATTERISTICHE

- comprende i seguenti adattatori con doppia sfera:
 - 1/4" M - 1/4" F, lunghezza 20 mm, art. 2841
 - 3/8" M - 3/8" F, lunghezza 30 mm, art. 3841
 - 1/2" M - 1/2" F, lunghezza 37 mm, art. 4841



ADATTATORI DOPPIO QUADRO MASCHIO

FEFMEC articolo	L mm	Euro
2841	1/4"	4,00
3841	3/8"	5,00
4841	1/2"	6,00
BGS 9623	NEW 3/4"	9,69

CARATTERISTICHE

- con doppia sfera



SNODO

attacco: 1/2"

BGS articolo	L mm	Euro
BGS 251	75	10,48



1/4"-3/8"-1/2"

1/4"-3/8"-1/2"



BGS articolo	DESCRIZIONE	Euro
BGS 252	SET 3 PEZZI SNODO CON MOLLA	26,01

CARATTERISTICHE

- cromati



PROLUNGHE

attacco: 1/2"

FEFMEC articolo	L mm	Euro
485-0050	50	5,25
BGS 236	75	6,30
BGS 3120	125	8,93
BGS 3121	250	12,60
BGS 3134	610	36,98



PRO



BGS articolo	DESCRIZIONE	Euro
BGS 2237	SET 3 PEZZI, PROLUNGHE	38,25

CARATTERISTICHE

- lunghezze: 450-600-750 mm
- acciaio al carbonio
- finitura lucida



PROLUNGHE CON TESTA SFERICA

attacco: 1/2"

FEFMEC articolo	L mm	Euro
BGS 233	50	6,30
4852-0075	75	6,83
BGS 234	125	9,45
BGS 235	250	15,75
BGS 248	375	24,48
BGS 249	500	31,50



BGS articolo	DESCRIZIONE	Euro
BGS 2240	SET 3 PEZZI PROLUNGHE	25,37

CARATTERISTICHE

- lunghezze: 50-125-250 mm
- **testa sferica**
- finitura cromata satinata
- zigrinate





NEW

1/2"



BGS articolo	DESCRIZIONE	Euro
BGS 6112	SET 5 PEZZI, PROLUNGHE TESTA SFERICA, ATT. 1/2"	41,08

CARATTERISTICHE

- comprende le seguenti misure:
 - att. 1/2", lunghezza: 50, 75, 125, 250, 450 mm
- finitura cromata lucida
- in supporto in plastica



NEW

1/4"-3/8"-1/2"



BGS articolo	DESCRIZIONE	Euro
BGS 6113	SET 9 PEZZI, PROLUNGHE TESTA SFERICA	40,04

CARATTERISTICHE

- comprende le seguenti misure:
 - att. 1/4", lunghezza: 50, 100, 225 mm;
 - att. 3/8", lunghezza: 75, 150, 225 mm;
 - att. 1/2", lunghezza: 50, 125, 250 mm.
- finitura cromata lucida
- in supporto in plastica



TESTA SFERICA

1/4"-3/8"-1/2"

PRO+

BGS articolo	DESCRIZIONE	Euro
BGS 2253	SET 9 PEZZI, PROLUNGHE TESTA SFERICA	55,97

CARATTERISTICHE

- comprende le seguenti misure:
 - att. 1/4", lunghezza: 50 mm, 100 mm, 250 mm;
 - att. 3/8", lunghezza: 75 mm, 150 mm, 250 mm;
 - att. 1/2", lunghezza: 50 mm, 125 mm, 250 mm.

RICAMBI

BGS articolo		L mm	Euro
BGS 2232	1/4"	50	3,57
BGS 2231	1/4"	100	3,83
BGS 2219	1/4"	250	6,63
BGS 242	3/8"	75	4,08
BGS 243	3/8"	150	5,87
BGS 244	3/8"	250	8,16
BGS 233	1/2"	50	6,30
BGS 234	1/2"	125	9,45
BGS 235	1/2"	250	15,75

FLEX



1/2"

PRO



CV

1/2"

BGS articolo	DESCRIZIONE	Euro
BGS 2323	PROLUNGA FLESSIBILE	28,05

CARATTERISTICHE

- lunghezza: 190 mm
- flessibile fino a 90°
- cromata

FLEX



1/2"

PRO+



1/2"

BGS articolo	DESCRIZIONE	Euro
BGS 8483	PROLUNGA FLESSIBILE, 300 MM, ATT. 1/2"	18,36

CARATTERISTICHE

- lunghezza: 300 mm
- permette l'avvitamento anche in aree difficili da raggiungere
- **ATTENZIONE: da non utilizzare per viti bloccate**



1/4"-3/8"-1/2"

1/4"-3/8"-1/2"

PRO+

CV



BGS articolo	DESCRIZIONE	Euro
BGS 198	SET 3 PEZZI PROLUNGHE MAGNETICHE	17,72

CARATTERISTICHE

- per trattenere viti e bulloni nella bussola



1/2"

PRO+



LED

1/2"

BGS articolo	DESCRIZIONE	Euro
BGS 3125	PROLUNGA CON ILLUMINAZIONE A LED INTEGRATA	23,75

CARATTERISTICHE

- lunghezza: 63 mm
- illumina l'area di lavoro attraverso la bussola
- batterie incluse



1/2" PRO+ CV

BGS articolo	DESCRIZIONE	Euro
BGS 289	ADATTATORE SCORREVOLE PER BARRE ATT. 1/2"	4,59

CARATTERISTICHE

- cromata, satinata
- per impiego con prolunghe



1/2"

QUADRO MASCHIO SCORREVOLE
attacco: 1/2"

BGS articolo	L mm		Euro
BGS 273	250	1	11,48
487	300	1	12,68



1/2"



LEVA CON QUADRO SCORREVOLE "POWER IMPACT" BRUNITA
Attacco: 1/2"

BGS articolo	1/2"	L mm		Euro
752050	1/2"	300	1	15,75



1/2"

QUADRO MASCHIO AD ANGOLO "POWER IMPACT" BRUNITO
Attacco: 1/2"

BGS articolo	1/2"	L mm		Euro
762051	1/2"	250	1	11,55



1/2" ESAGONO PRO+

BGS articolo	DESCRIZIONE	Euro
BGS 1459	CHIAVE A CROCE PER RUOTE DI AUTOMOBILI	15,17

CARATTERISTICHE

- esagono 17, 19, 21 mm, quadro maschio da 1/2"
- finitura cromata, temperata
- lunghezza braccio 150 mm
- conforme DIN 899



1/2" ESAGONO PRO+

BGS articolo	DESCRIZIONE	Euro
BGS 1456	CHIAVE A CROCE PER RUOTE DI AUTOMOBILI, RIPIEGABILE, GIUNTO ARTICOLATO	56,61

CARATTERISTICHE

- esagono 17, 19, 21 mm + quadro maschio 1/2"
- lunghezza 400 mm
- maggiore coppia grazie al giunto regolabile



1/2" ESAGONO  

BGS articolo	DESCRIZIONE	Euro
BGS 1510	CHIAVE PER DADI RUOTA ESTENSIBILE, ATTACCO 1/2", 17-19 MM	14,82

CARATTERISTICHE

- bussola intercambiabile con attacco quadro femmina da 1/2", un lato 17 mm esagonale, l'altro lato esagonale 19 mm
- impugnatura rivestita in gomma
- barra estensibile in lunghezza fino a 520 mm



BGS 265-REPAIR

BGS articolo	1/2"	L mm	Euro
BGS 265	1/2"	250	18,62
BGS 267	1/2"	610	40,00

CARATTERISTICHE

- cromata
- attacco quadro nero
- coppia massima 500 Nm

RICAMBI

BGS articolo	DESCRIZIONE	Euro
BGS 265-REPAIR	KIT DI RIPARAZIONE PER ART. BGS 265	5,87
BGS 267-REPAIR	KIT DI RIPARAZIONE PER ART. BGS 267	11,99



1/2" PRO+ CV CROMO

BGS articolo	DESCRIZIONE	Euro
BGS 258	IMPUGNATURA SNODATA ESTENSIBILE	56,48

CARATTERISTICHE

- lunghezza: da 450 a 600 mm
- finitura satinata cromata
- testa con finitura nera
- coppia massima 550 Nm

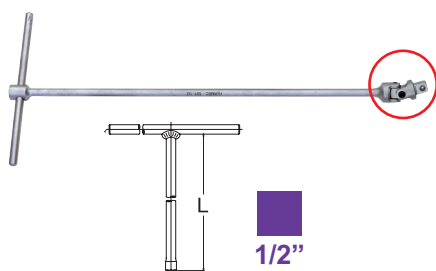
CHIAVE A "T" QUADRO MASCHIO SNODATA CROMATE ASTA SCORREVOLE CHROM-VANADIUM

FEEMEC articolo	1/2"	L mm	1	Euro
581-1/2"	1/2"	500	1	21,00



1/2" PRO+ CV

BGS articolo	DESCRIZIONE	Euro
BGS 7805	IMPUGNATURA A T, CON QUADRO MASCHIO DA 1/2", LUNGHEZZA 230 MM	16,07

CARATTERISTICHE

- impugnatura ergonomica
- finitura satinata



1/2" PRO+ CV

BGS articolo	DESCRIZIONE	Euro
BGS 7805-1	IMPUGNATURA A T, CON QUADRO MASCHIO DA 1/2", LUNGHEZZA 230 MM, TESTA SFERICA	17,21

CARATTERISTICHE

- impugnatura ergonomica
- finitura satinata



1/2" PRO+

BGS articolo	DESCRIZIONE	Euro
BGS 25150	CHIAVE A BATTERE PER DADI E PULGEGE	101,75

CARATTERISTICHE

- 620 mm
- idoneo per diverse applicazioni, ad esempio allentamento della vite di tenuta puleggia cinghia, contralbero
- offre un'elevata coppia di allentamento in condizioni di spazio limitato
- speciale impugnatura di sicurezza antiscivolo

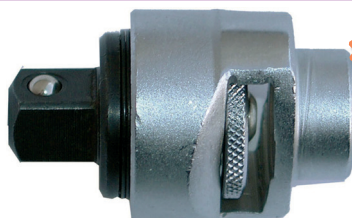

MECCANISMO 72 DENTI

1/2" PRO 1/2"

BGS articolo	DESCRIZIONE	Euro
BGS 2301	ADATTATORE CHIAVE A CRICCHETTO DA 1/2"	38,76

CARATTERISTICHE

- reversibile
- di semplice utilizzo in combinazione con impugnatura BGS 265 o barra scorrevole a T da 1/2"
- lunghezza: 60 mm
- Ø max: 40 mm

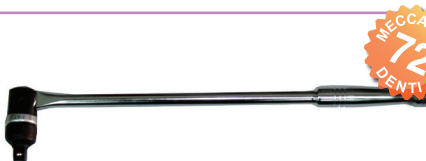

BGS articolo	DESCRIZIONE	Euro
BGS 228-1	IMPUGNATURA SNODATA CON TESTA A CRICCHETTO	76,37

CARATTERISTICHE

- lunghezza 620 mm
- coppia massima 512 Nm

RICAMBI

BGS articolo	DESCRIZIONE	Euro
BGS 228-1	KIT DI RIPARAZIONE	34,43

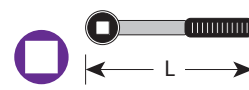
CRICCHETTO REVERSIBILE CON QUADRO FEMMINA PASSANTE

FEEMEC articolo	1/2"	L mm	Euro
BGS 9160	NEW 1/4"	115	23,14
3940	3/8"	260	28,00
BGS 312	1/2"	270	38,00
5840	3/4"	450	60,00
BGS 9622	NEW 3/4"	500	123,68
6040	10 mm	250	30,00
6340	13 mm	250	38,00
6540	15 mm	250	38,00
6640	16 mm	250	38,00

CARATTERISTICHE

- quadro passante
- impugnatura rivestita



1/2"

CRICCHETTO REVERSIBILE CON QUADRO MASCHIO INTERCAMBIABILE - ESTRAIBILE

attacco: 1/2"

FEEMEC articolo	L mm	1	Euro
484	280	1	42,00



1/2" PRO+ CV

BGS articolo	DESCRIZIONE	Euro
BGS 314	CHIAVE A CRICCHETTO PASSANTE CON CHIAVI SPECIALI	53,42

CARATTERISTICHE

- chiave di montaggio da 3/8" - 7/16" - 1/2" - 5/8" - 13/16"
- attacco quadro da 1/2"
- finitura cromata satinata

MECCANISMO 36 DENTI



1/2"

CRICCHETTO REVERSIBILE 36 DENTI CON PULSANTE DI BLOCCAGGIO BUSSOLA
attacco: 1/2"

FERMEC	L		Euro
articolo	mm		
483	280	1	43,05



1/2"



NUOVI CRICCHETTI REVERSIBILI A 72 DENTI CON PULSANTE DI SBLOCCAGGIO DELLA BUSSOLA ED IMPUGNATURA ERGONOMICA BI-COMPONENTE ANTISCIVOLO E FORMA OVALE

FERMEC	L		Euro
articolo	mm		
872	250	1	36,75

576787	SET 3 PEZZI 1/4" - 3/8" - 1/2"	1	94,50
--------	-----------------------------------	---	-------

MECCANISMO 72 DENTI



1/4"-3/8"-1/2" **PRO+** **CV**

BGS	DESCRIZIONE	Euro
articolo		
BGS 215	SET 3 PEZZI, CRICCHETTI REVERSIBILI COMPATTI	95,63

CARATTERISTICHE

- formato extra-small per spazi ridotti e angusti
- 72 denti
- lunghezza cricchetti:
 - attacco 1/4": 110 mm
 - attacco 3/8": 140 mm
 - attacco 1/2": 170 mm



MECCANISMO 72 DENTI

1/2" **CV**

BGS	DESCRIZIONE	Euro
articolo		
BGS 519	CRICCHETTO REVERSIBILE, 72 DENTI, ATTACCO 1/2"	26,26

CARATTERISTICHE

- impugnatura in materiale bi-componente
- con sgancio rapido
- lunghezza 255 mm



MECCANISMO 72 DENTI

1/2" **PRO+** **CV**

BGS	DESCRIZIONE	Euro
articolo		
BGS 320	CRICCHETTO REVERSIBILE 1/2"	41,82

CARATTERISTICHE

- con pulsante di sgancio rapido
- stelo sfasato
- impugnatura ergonomica antiscivolo in materiale bi-componente
- lunghezza 255 mm

NEW





1/2" **CV** **PRO+**

BGS	DESCRIZIONE	Euro
articolo		
BGS 612	CRICCHETTO REVERSIBILE, "EXTRA SLIM", ATTACCO 1/2"	49,73

CARATTERISTICHE

- cricchetto reversibile 72 denti
- modello dritto "extra slim"
- con pulsante di sgancio rapido
- acciaio al Cromo Vanadio
- lunghezza: 250 mm
- peso: 420 grammi
- impugnatura in materiale bi-componente

NEW





BGS 602-REPAIR



1/2" **CV** **PRO+**

BGS	DESCRIZIONE	Euro
articolo		
BGS 602	CRICCHETTO REVERSIBILE, MODELLO CURVO, ATTACCO 1/2"	26,78

BGS 602-REPAIR



1/2" **CV** **PRO+**

BGS	DESCRIZIONE	Euro
articolo		
BGS 602	CRICCHETTO REVERSIBILE, MODELLO CURVO, ATTACCO 1/2"	26,78

CARATTERISTICHE

- cricchetto reversibile 90 denti
- modello curvo
- con pulsante di sgancio rapido
- acciaio al Cromo Vanadio
- lunghezza: 255 mm
- peso: 550 grammi
- impugnatura in materiale bi-componente

RICAMBI

BGS	DESCRIZIONE	Euro
articolo		
BGS 602-REPAIR	SET RIPARAZIONE CRICCHETTO	10,07

XXL



MECCANISMO 72 DENTI

1/2" **PRO+** **CV**

BGS	DESCRIZIONE	Euro
articolo		
BGS 324	CRICCHETTO REVERSIBILE EXTRA LUNGO	56,25

CARATTERISTICHE

- 72 denti
- lunghezza 380 mm
- impugnatura ergonomica antiscivolo in materiale bi-componente



1/2"

PRO+

BGS
articolo

DESCRIZIONE

Euro

BGS 2206

**CHIAVE A CRICCHETTO
REVERSIBILE 1/2"**

36,98

CARATTERISTICHE

- impugnatura in ABS
- con pulsante di sgancio rapido
- lunghezza 260 mm



1/2"

PRO+

BGS
articolo

DESCRIZIONE

Euro

BGS 2304

**CRICCHETTO
REVERSIBILE 1/2"**

33,92

CARATTERISTICHE

- con pulsante di sgancio rapido
- impugnatura in gomma in materiale bi-componente
- lunghezza 210 mm



1/2"

PRO+

BGS
articolo

DESCRIZIONE

Euro

BGS 317

**CRICCHETTO
REVERSIBILE 1/2"**

39,53

CARATTERISTICHE

- con pulsante di sgancio rapido
- impugnatura ergonomica antiscivolo in materiale bi-componente
- lunghezza 255 mm



1/2"

PRO+

BGS
articolo

DESCRIZIONE

Euro

BGS 210

**CRICCHETTO
"COMPATTO" 1/2"**

36,98

CARATTERISTICHE

- extra-piccolo
- lunghezza 170 mm
- 72 denti
- con pulsante di sgancio rapido



1/2"

PRO+

BGS
articolo

DESCRIZIONE

Euro

BGS 304

**CHIAVE A CRICCHETTO
IN NYLON E FIBRA DI
VETRO 1/2"**

33,66

CARATTERISTICHE

- con pulsante di sgancio rapido
- comodo utilizzo grazie ai materiali ultra-leggeri, nessun affaticamento
- i test su questo attrezzo hanno ottenuto risultati per capacità massima decisamente superiori ai limiti DIN
- lunghezza: circa 255 mm
- in polipropilene rivestito in acciaio CR-V con impugnatura in materiale bi-componente



1/2"

BGS
articolo

DESCRIZIONE

Euro

BGS 2300

**CRICCHETTO
"KRAFTMANN" 1/2"**

15,34

CARATTERISTICHE

- reversibile
- con impugnatura ergonomica in gomma
- lunghezza 240 mm



1/2"

PRO+

BGS
articolo

DESCRIZIONE

Euro

BGS 25108

**CRICCHETTO
REVERSIBILE
ESTENSIBILE,
450-610 MM,
ATTACCO 1/2"**

62,73

CARATTERISTICHE

- regolabile in 6 posizioni da 450 a 610 mm
- cricchetto 72 denti
- con pulsante di sgancio rapido

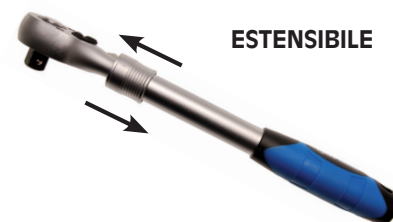

ESTENSIBILE

1/2"

PRO+

BGS
articolo

DESCRIZIONE

Euro

BGS 25104

**CRICCHETTO
REVERSIBILE
ESTENSIBILE, 305-445
MM, ATTACCO 1/2"**

50,87

CARATTERISTICHE

- regolabile in 5 posizioni da 305 a 445 mm
- acciaio al cromo vanadio, satinato
- cricchetto 72 denti
- con pulsante di sgancio rapido



MECCANISMO
48
DENTI

BGS 2315-REPAIR



1/2" PRO+

BGS articolo	DESCRIZIONE	Euro
BGS 2315	CHIAVE A CRICCHETTO ESTENSIBILE	105,83

CARATTERISTICHE

- la testa può essere utilizzata con 3 impugnature di diversa lunghezza; ne consegue una cricchetto di lunghezza totale potenziale di: 220 mm, 360 mm, 565 mm
- coppia massima 575 Nm

RICAMBI

BGS articolo	DESCRIZIONE	Euro
BGS 2315-REPAIR	KIT DI RIPARAZIONE	19,13



TESTA
SNODATA
90°

MECCANISMO
45
DENTI

1/2" PRO+ CV

BGS articolo	DESCRIZIONE	Euro
BGS 287	CHIAVE A CRICCHETTO CON TESTA SNODATA, REGOLABILE 1/2"	58,75

CARATTERISTICHE

- finitura satinata cromata
- regolabili in sicurezza in 5 posizioni
- 45 denti
- con pulsante di sgancio rapido
- impugnatura con occhiello
- lunghezza 290 mm



QUANDO MANCA LO SPAZIO

RUOTANDO L'IMPUGNATURA SI OTTIENE LA ROTAZIONE DEL QUADRO DX/SX

1/2"

- CRICCHETTO DOPPIA FUNZIONE:**
- AZIONE A "CRICCO TRADIZIONALE"
 - IMPUGNATURA ROTATIVA
 - QUADRO MASCHIO SCORREVOLE

BGS articolo	L mm	1	Euro
972	280	1	48,50

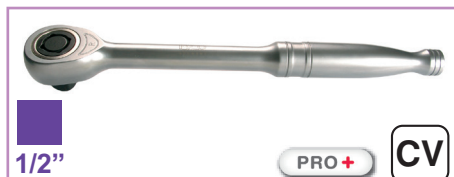

1/2" PRO+ CV

BGS articolo	DESCRIZIONE	Euro
BGS 2272	CHIAVE A CRICCHETTO A RUOTA LIBERA (SENZA DENTI) 1/2"	59,93

CARATTERISTICHE

- con quadro maschio scorrevole
- elimina l'angolo di ripresa dei cricchetti tradizionali
- ideale per l'utilizzo in spazi ridotti
- lunghezza 245 mm



TESTA SNODATA + ESTENSIBILE

MECCANISMO
72
DENTI

1/2" PRO+ CV

BGS articolo	DESCRIZIONE	Euro
BGS 25107	CRICCHETTO REVERSIBILE ESTENSIBILE SNODATO, 345-495 MM, ATTACCO 1/2"	66,30

CARATTERISTICHE

- regolabile in 6 posizioni da 345 a 495 mm
- testa snodata 180°, regolabile in 10 posizioni
- cricchetto 72 denti
- con pulsante di sgancio rapido
- acciaio al cromo vanadio
- lunghezza 290 mm



TESTA SNODATA

1/2" PRO+ MECCANISMO 72 DENTI

BGS articolo	DESCRIZIONE	Euro
BGS 114	CHIAVE A CRICCHETTO CON TESTA SNODATA, REGOLABILE, 1/2"	55,97

CARATTERISTICHE

- testa snodata 180°
- finitura cromata
- cricchetto reversibile 72 denti
- con pulsante di sgancio rapido
- lunghezza 310 mm



1/2"



1/4"-3/8"-1/2"



TORX®

- 5 BUSSOLE TORX® FEMMINA ATT. 1/4" E 4-5-6-7-8
- 5 BUSSOLE TORX® FEMMINA ATT. 3/8" E 10-11-12-14-16
- 4 BUSSOLE TORX® FEMMINA ATT. 1/2" E 18-20-22-24

attacco: 1/4" - 3/8" - 1/2"
 impronta: TORX®

FEFMEC articolo	Descrizione	Impronta	Euro
54214	CASSETTA PLASTICA 14 PEZZI	1	44,10



1/2"



TORX® TORX®

- 9 BUSSOLE TORX® FEMMINA
- E 10-11-12-14-16-18-20-22-24
- 10 BUSSOLE CON INSERTI TORX®
- T 20-25-27-30-40-45-50-55-60-70

attacco: 1/2"
 impronta: TORX®

FEFMEC articolo	Descrizione	Impronta	Euro
54019	CASSETTA PLASTICA 19 PEZZI	1	57,75



TORX® TORX® CON FORO 1/4"-1/2"

FEFMEC articolo	DESCRIZIONE	Euro
2271	SET 72 PEZZI, UTENSILI TORX ATT. 1/4" + 1/2"	115,00

CARATTERISTICHE

- bussole torx femmina:
 - att. 1/4": E4 - E5 - E6 - E7 - E8 - E10 - E11
 - att. 1/2": E12 - E14 - E16 - E18 - E20 - E22 - E24
- chiavi a bussola Torx, att. 1/4": TX10 - TX15 - TX20 - TX25 - TX27 - TX30
- inserti att. 10 mm, lunghezza 30 mm, Torx c/ foro: TH40 - TH45 - TH50 - TH55 - TH60 - TH70
- inserti att. 10 mm, lunghezza 75 mm, Torx: TX15 - TX20 - TX25 - TX30 - TX40 - TX45 - TX50 - TX55 - TX60
- inserti att. 1/4", lunghezza 25 mm:
 - Torx: TX7 - TX8 - TX9
 - Torx con foro: TH10 - TH15 - TH20 - TH25 - TH27 - TH30 - TH40
- Chiave Torx tipo L: TX8 - TX10 - TX15 - TX20 - TX25 - TX27 - TX30 - TX40 - TX45 - TX50 - TX55 - TX60
- cacciaviti Torx: TX8 - TX10 - TX15 - TX20 - TX25 - TX27 - TX30 - TX40
- chiavi doppio anello: E6 x E8 - E10 x E12 - E14 x E18 - E20 x E24
- adattatori
 - portainseri esag. fem. 1/4" - quadro fem. 1/4"
 - portainseri esag. fem. 10 mm - quadro fem. 1/2"
- utensile di raccolta magnetico



1/2"



TORX®



PRO+

BGS articolo	DESCRIZIONE	Euro
BGS 6425	SET 9 PEZZI, BUSSOLE TIPO TORX	31,62

CARATTERISTICHE

- E10-11-12-14-16-18-20-22-24
- finitura satinata cromata



TORX® CON FORO



1/2"

PRO+



BGS articolo	DESCRIZIONE	Euro
BGS 5101	SET 27 PEZZI INSERTI E CHIAVI A BUSSOLA TORX	55,46

CARATTERISTICHE

- conformi DIN
- 5 chiavi a bussola attacco da 1/2" T45-50-55-60-70
- 7 inserti per viti Torx Tx10-15-20-25-27-30-40
- 12 inserti Torx c/foro: Th10-15-20-25-27-30-40-45-50-55-60-70
- 3 adattatori per inserti attacco da 1/4" - 3/8" - 1/2"

TORX®	S mm	S mm	S mm
E 4	3.70	E 16	14.60
E 5	4.60	E 18	16.50
E 6	5.60	E 20	18.30
E 7	6.10	E 22	20.10
E 8	7.40	E 24	22.00
E 10	9.30	E 26	23.70
E 11	9.90	E 28	25.50
E 12	11.00	E 30	27.30
E 14	12.80	E 32	29.00





TORX® TORX® CON FORO 1/4"-1/2"

PRO+ CV

BGS articolo	DESCRIZIONE	Euro
BGS 7849	SET 84 PEZZI, UTENSILI TORX ATT. 1/4" + 1/2"	206,25

CARATTERISTICHE

- utensili attacco 1/2":
 - bussole: E12 - E14 - E16 - E18 - E20 - E22 - E24
 - adattatore portainserti attacco 10 mm
 - adattatore portainserti attacco 14 mm
- utensili att. 1/4":
 - bussole: E4 - E5 - E6 - E7 - E8 - E10 - E11
 - chiavi a bussola att. 1/4", lunghezza 37 mm
 - Torx: TX10 - TX15 - TX20 - TX25 - TX27 - TX30
 - adatt. portainserti att. 1/4"
- inserti attacco 10 mm, lunghezza 30 mm, Torx con foro: TH40 - TH45 - TH50 - TH55 - TH60 - TH70
- inserti att. 10 mm, lunghezza 75 mm, Torx: TX15 - TX20 - TX25 - TX30 - TX40 - TX45 - TX50
- inserti attacco 14 mm:
 - lunghezza 40 mm, Torx c/foro: TX80-TX90-TX100
 - lunghezza 75 mm, Torx: TX55 - TX60
- inserti attacco 1/4" esagonale:
 - lunghezza 25 mm, 5 punte con foro: TS7-TS8-TS9
 - lunghezza 25 mm, Torx con foro: TH10-TH15-TH20-TH25 - TH27 - TH30 - TH40
 - Torx con foro: TX10 - TX15-TX20-TX25-TX27-TX30 TX40 - TX45
- Chiave Torx tipo L: TX8- TX10- TX15- TX20- TX25 TX27- TX30- TX40- TX45- TX50- TX55- TX60
- chiavi doppio anello: E6 x E8, E10 x E12, E14 x E18, E20 x E24
- cacciavite Torx con foro: TH8 - TH10 - TH15 - TH20 - TH25 - TH27 - TH30 - TH40
- asta magnetica telescopica



1/2" CV PRO+ ESAGONO

BGS articolo	DESCRIZIONE	Euro
BGS 2224	SET 27 PEZZI, BUSSOLE ATT. 1/2", 8-32 MM	131,25

CARATTERISTICHE

- conformi DIN
- bussole esagonali
- cricchetto reversibile da 72 denti
- 2 prolunghe testa sferica: 125 + 250 mm
- 1 quadro scorrevole per prolunghe
- 1 snodo
- 2 bussole per candele: 16 + 21 mm
- 20 bussole esagonali: 8-9-10-11-12-13-14-15-16 17-18-19-20-21-22-23-24-27-30-32 mm

RICAMBI

BGS articolo	DESCRIZIONE	Euro
BGS 2224-LEER	CASSETTA VUOTA	19,13



1/2" CV PRO+ ESAGONO

BGS articolo	DESCRIZIONE	Euro
BGS 2216	SET 27 PEZZI, BUSSOLE ATT. 1/2", IN POLLICI	131,25

CARATTERISTICHE

- conformi DIN
- bussole esagonali
- cricchetto reversibile da 72 denti
- 2 prolunghe testa sferica: 125 + 250 mm
- 1 quadro scorrevole per prolunghe
- 2 bussole per candele: 5/8" + 13/16"
- 20 bussole esagonali: 5/16" - 11/32" - 3/8" - 7/16" 15/32" - 1/2" - 9/16" - 19/32" - 5/8" - 21/32" 11/16" - 3/4" - 25/32" - 13/16" - 7/8" - 15/16" - 1" 1 1/16" - 1 3/16" - 1 1/4"



1/2" ESAGONO

CV

BGS articolo	DESCRIZIONE	Euro
BGS 15110	SET 19 PEZZI, CRICCHETTO E BUSSOLE, ATTACCO 1/2"	71,50

CARATTERISTICHE

- cricchetto reversibile attacco 1/2"
- 18 bussole esagonali attacco quadro 1/2": 8 - 9 - 10 - 11 - 12 - 13 - 14 - 15 - 16 - 17 - 19 - 21 - 22 23 - 24 - 27 - 30 - 32 mm
- con supporto in plastica

SET 1/2"



CASSETTA BUSSOLE MULTIMPRONTA
ATTACCO 1/2" ADATTE PER DADI
ESAGONALI POLIGONALI - POLLICI
QUADRI - XZN® - TORX®
PEZZI 42 DA 10-32 MM
+ INSERTI XZN, ESAGONO E TORX

articolo	Descrizione	Euro
FRM 4422	VALIGETTA 42 PEZZI	130,00



articolo	DESCRIZIONE	Euro
BSG 9366	SET 44 PEZZI, BUSSOLE PASSANTI	211,25

CARATTERISTICHE

- ideale per avvitare dadi con fuoriuscita del filetto
- materiale:
 - bussole in acciaio Chrome-Vanadium
 - inserti in acciaio Chrome-Vanadium S2
- comprende:
 - cricchetto passante, 72 denti, misura interna 12 mm
 - bussole esagonali passanti, attacco speciale 12 mm: 6-7-8-9-10-11-12-13-14 mm
 - adattatore attacco speciale 12 mm-quadro maschio 3/8"
 - 33 inserti in acciaio S2, attacco speciale 12 mm
 - XZN: M4 - M5 - M6 - M8 - M10 - M12
 - RIBE: M5 - M6 - M7 - M8 - M10 - M12 - M13
 - Torx: TX15-TX20-TX25-TX27-TX30-TX40-TX45
 - Torx c/Foro: TH15-TH20-TH25-TH27-TH30-TH40-TH45
 - Esagonali: 4 - 5 - 6 - 7 - 8 - 10 mm

PROMO

NEW



BSG 2181-1

BSG 2181-2

BSG 2181-3

BUSSOLE MULTIMPRONTA



articolo	DESCRIZIONE	Euro
BSG 2181	SET 52 PEZZI, BUSSOLE PASSANTI MULTIMPRONTA, 4,5 - 25 MM	241,25

CARATTERISTICHE

- particolarmente adatto per avvitare dadi con fuoriuscita del filetto
- non limitata la profondità come nelle normali bussole
- utensili con attacco esagonale da 13 mm:
 - cricchetto passante, 72 denti, esagono femmina da 13 mm
 - prolunga, 75 mm, con foro passante
 - 11 bussole multimpronta, lunghezza 25 mm: 4,5-5-5,5-6-7-8-9-10-11-12-13 mm
 - adattatore esagono maschio 13 mm - quadro maschio 1/4"
 - adattatore esagono maschio 13 mm - quadro maschio 1/4", per uso con prolunga con foro passante
 - adattatore portainseriti, esagono maschio 13 mm - esagono femmina 1/4", permette l'uso del cricchetto come cricchetto portainseriti 1/4" standard
- utensili con attacco esagonale da 19 mm:
 - cricchetto passante, 72 denti, esagono femmina da 19 mm
 - prolunga, 75 mm, con foro passante
 - 11 bussole multimpronta, lunghezza 30 mm: 8-10-11-12-13-14-15-16-17-18-19 mm
 - adattatore esagono maschio 19 mm - quadro maschio 3/8"
 - adattatore esagono maschio 19 mm - quadro maschio 3/8", per uso con prolunga con foro passante
- utensili con attacco esagonale da 22 mm:
 - cricchetto passante, 72 denti, esagono femmina da 22 mm
 - prolunga, 75 mm, con foro passante
 - 7 bussole multimpronta, lunghezza 40 mm: 19-20-21-22-23-24-25 mm
 - adattatore esagono maschio 22 mm - quadro maschio 1/2"
 - adattatore esagono maschio 22 mm - quadro maschio 1/2", per uso con prolunga con foro passante
- 10 inserti con attacco esagonale 1/4":
 - Taglio: 4 e 5 mm
 - PH1 e PH2
 - Torx: TX10 - Tx15 - Tx20
 - Esagono: 4 - 5 - 6 mm

RICAMBI

articolo	DESCRIZIONE	Euro
BSG 2181-1	CRICCHETTO PASSANTE 13 MM	23,46
BSG 2181-2	CRICCHETTO PASSANTE 19 MM	28,56
BSG 2181-3	CRICCHETTO PASSANTE 22 MM	38,76



PROMO

NEW



BUSSOLE ESAGONALI



1/4"



BGS articolo	DESCRIZIONE	Euro
BGS 2039	CASSETTA 84 PEZZI CHIAVI A BUSOLA E UTENSILI ASSORTITI	250,90

CARATTERISTICHE

- comprende:
- chiavi combinate, finitura satinata cromata: 8 - 9 - 10 - 11 - 12 - 13 - 14 - 17 - 19 - 21 mm
- utensili con attacco quadro 3/8":
 - cricchetto reversibile, 72 denti
 - snodo
 - prolunga, 150 mm
 - adattatore portainseriti con attacco 1/4"
 - bussole, finitura satinata cromata: 8 - 10 - 11 - 12 - 13 - 14 - 15 - 16 - 17 - 18 - 19 - 21 - 22 mm
 - bussola esagonale per candele 16 mm, con inserto in gomma, lungh. 64 mm
 - bussola esagonale per candele 21 mm, con inserto in gomma, lungh. 64 mm
- inserti attacco esagonale 1/4":
 - taglio: 4,0 - 5,5 - 6,5 mm
 - PH: PH1 - PH1 - PH2 - PH2 - PH3 - PH3
 - PZ: PZ1 - PZ1 - PZ2 - PZ2 - PZ3 - PZ3
 - Torx: TX8 - TX9 - TX10 - TX15 - TX20 - TX25 - TX27 - TX30 - TX40
 - esagonali: 3 - 4 - 5 - 6 - 7 - 8 mm
 - portainseriti
- cacciaviti:
 - taglio: 1.2x8.0x150 - 1.0x5.5x100 mm
 - PH: PH1x100 - PH2x100 - PZ2x100 mm
 - impugnatura portainseriti con attacco esagonale 1/4", lunghezza 75 mm
 - tester (taglio 3x60)
- chiavi combinate, finitura satinata cromata: 8 - 9 - 10 - 11 - 12 - 13 - 14 - 17 - 19 - 21 mm
- chiavi a L esagonali con testa sferica sul lato lungo: 1,5 - 2 - 2,5 - 3 - 4 - 5 - 6 - 8 - 10 mm
- pinza regolabile, 245 mm
- pinze, 180 mm
- tronchese con tagliente laterale, 160 mm
- martello, 300 g
- seghetto, 300 mm, con lama
- flessometro, 5 m
- cutter con lame 18 mm, con 1 lama
- asta telescopica magnetica, magneti 11 mm, lunghezza 132 - 570 mm

PROMO

NEW



BUSSOLE ESAGONALI



1/4"



BGS articolo	DESCRIZIONE	Euro
BGS 2037	CASSETTA 58 PEZZI, CHIAVI A BUSOLA E UTENSILI ASSORTITI	110,50

CARATTERISTICHE

- comprende:
- utensili con attacco quadro 1/4":
 - cricchetto reversibile, 72 denti
 - prolunga, 50 mm
 - adattatore portainseriti con attacco 1/4"
 - bussole, finitura satinata cromata: 4 - 6 - 7 - 8 - 9 - 10 - 11 - 12 - 13 mm
- inserti attacco esagonale 1/4":
 - taglio: 3 - 4 - 5 - 6 mm
 - PH: PH1 - PH2 - PH3
 - PZ: PZ1 - PZ2 - PZ3
 - Torx: T10 - T15 - T20 - T25 - T27 - T30
 - esagonali: 3 - 4 - 5 - 6 mm
- cacciaviti:
 - taglio: 0,4x2,0x50 mm - 0,4x2,5x50 mm - 0,5x3,0x50 mm
 - 1,0x5,5x75 mm - 1,2x6,5x38 mm - 1,2x6,5x100 mm
 - PH: PH00x50 mm - PH0x50 mm - PH1x75 mm
 - PH2x38 mm - PH2x100 mm
 - impugnatura portainseriti con attacco esagonale 1/4", lunghezza 75 mm
- chiavi a L esagonali: 1,5 - 2 - 2,5 - 3 - 4 - 5 - 6 - 8 - 10 mm
- pinza regolabile, 245 mm
- pinze, 180 mm
- pinze a becchi mezzotondi dritti, 200 mm
- martello, 300 g

SET 1/2"



NEW



assortimento speciale
per CAMIONISTI



BUSSOLE
ESAGONALI



1/2"



FERMEC	DESCRIZIONE	Euro
articolo	CASSETTA 58 PEZZI, CHIAVI A BUSSOLA E UTENSILI ASSORTITI PER TRUCK	250,00
64230		

CARATTERISTICHE

- assortimento particolarmente indicato per operazioni su veicoli pesanti/trucks
- cassetta in ABS ad alta resistenza con 4 chiusure
- dimensioni cassetta: (lunghezza x larghezza x altezza) 535 x 420 x 100 mm
- comprende:
 - 18 chiavi combinate: 7 - 8 - 10 - 11 - 12 - 13 - 14 - 15 - 16 - 17 - 18 - 19 - 21 - 22 - 24 - 27 - 30 - 32 mm
 - 16 chiavi a bussola esagonali att. 1/2": 10 - 11 - 12 - 13 - 14 - 15 - 16 - 17 - 18 - 19 - 21 - 22 - 24 - 27 - 30 - 32 mm
 - 4 chiavi a L esagonali: 4 - 6 - 8 - 10 mm
 - 4 chiavi a L Torx: TX10 - TX20 - TX25 - TX30
 - 2 prolunghe att. 1/2": 125, 250 mm
 - snodo, att. 1/2"
 - testa scorrevole per prolunghe, att. 1/2"
 - 3 cacciaviti taglio: 5,5 x 125 mm - 6,5 x 150 mm - 6 x 38 mm
 - 3 cacciaviti PH: PH1 X 75 mm - PH2 X 100 mm - PH 2 X 38 mm
 - cricchetto reversibile con sgancio rapido, att. 1/2"
 - cacciavite cercafase 250 V
 - martello 300 gr
 - pinza universale 180 mm
 - pinze giratubi regolabili 250 mm
 - forbici 140 mm

NEW PROMO

BUSSOLE ESAGONALI

PRO+



BGS articolo	DESCRIZIONE	Euro
BGS 9029	CASSETTA 117 PEZZI CHIAVI A BUSSOLA E UTENSILI ASSORTITI	299,90

CARATTERISTICHE

- utensili attacco 1/4":
 - cricchetto con sgancio rapido, 72 denti, lunghezza 145 mm, impugnatura in materiale bi-componente
 - bussole esagonali: 4-5-6-7-8-9-10-11-12-13 mm
 - bussole esagonali lunghe: 9-10-11-12-13 mm
 - impugnatura attacco quadro 150 mm
 - snodo
 - prolunga 50 mm
 - adattatore portainseriti attacco 1/4" esagonale
- utensili attacco 1/2":
 - cricchetto con sgancio rapido, 72 denti, lunghezza 145 mm, impugnatura in materiale bi-componente
 - bussole esagonali: 10-11-12-13-14-15-17-19-22-24-27-30-32 mm
 - prolunga 125 mm
 - snodo
- set 32 inserti att. 1/4" colorati lunghezza 25 mm
 - Taglio 3-4-5-6 mm
 - PH: 1-2-2-3
 - PZ: 1-2-2-3
 - Esagonali: 3-4-5-6 mm
 - Torx: TX10-15-20-25-27-30-40
 - Torx con Foro: TH10-15-20-25-27-30-40
 - adattatore portabussole
 - portainseriti a sgancio rapido
- chiavi combinate finitura satinata cromata: 6 - 7 - 8 - 9 - 10 - 11 - 12 - 13 - 14 - 17 - 19 - 22 mm
- tronchese taglio diagonale, 165 mm, impugnature in materiale bi-componente
- pinza, 175 mm, impugnature in materiale bi-componente
- pinza regolabile, 240 mm, impugnature rivestite, apertura max 38 mm
- pinza per crimpatura 235 mm
 - per morsetti non isolati di formato: 1,5 - 2,5 - 4,6 mm
 - per morsetti isolati di formato: 1,5 mm (rosso) - 2,5 mm (blu) - 6 mm (giallo)
 - spellafili: 0,75 - 1,0 - 1,5 - 2,5 - 4,0 - 6,0 mm
 - tagliabulloni per teste bulloni: M2,6 - M3 - M3,5 - M4 - M5
- assortimento terminali isolati
- cacciaviti Taglio: 6x38, 6x100, 8x150 mm
- cacciaviti: PH2x38, PH2x100 mm
- martello tipo tedesco, impugnatura in hickory, 300 g
- torcia a led estensibile con magnete
 - asta telescopica estensibile da 170 a 545 mm con testa magnetica flessibile per sollevare oggetti in metallo
 - 3 led ad alta luminosità e lunga durata
 - corpo in alluminio con clip
 - capacità magnete: 1 kg
 - diametro: 25 mm
 - alimentazione 4 batterie LR44, incluse

NEW

BUSSOLE ESAGONALI

BGS articolo	DESCRIZIONE	Euro
BGS 2204	CASSETTA IN ALLUMINIO CON 129 UTENSILI	250,00

CARATTERISTICHE

- comprende:
 - cutter con lama 18 mm + 10 lame di ricambio
 - chiave regolabile a rullino, 200 mm
 - pinza regolabile, 250 mm
 - pinza, 175 mm
 - pinza becchi mezzotondi lunghi, 200 mm
 - livella, 230 mm
 - flessometro, 15 mm x 3 m
 - chiave a cricchetto reversibile, att. quadro 1/4", 72 denti
 - prolunga, att. quadro 1/4", 100 mm
 - impugnatura, att. quadro 1/4", 150 mm
 - set 13 bussole su guida, att. quadro 1/4":
 - 4 - 4,5 - 5 - 5,5 - 6 - 7 - 8 - 9 - 10 - 11 - 12 - 13 - 14 mm
 - adattatore portainseriti: quadro 1/4" - esagono 1/4"
 - inserti attacco esagonale 1/4":
 - 19 pezzi, taglio 3 - 8 mm
 - 11 pezzi, esagonale 2 - 8 mm
 - 8 pezzi, PZ0 - PZ3
 - 8 pezzi, PH0 - PH3
 - 10 pezzi, Torx, TX8 - TX40
 - 4 pezzi, quadro 2 - 3,5 mm
 - 1 portainseriti
 - tester a cacciavite, 100 - 250 volt
 - mini cacciavite:
 - taglio: 2,5x50 mm
 - PH: PH00x50 mm
 - cacciaviti a taglio: 5,5x75 mm, 6,5x100 mm, 8x125 mm
 - cacciaviti PH: PH1x75 mm, PH2x100 mm
 - impugnatura portainseriti, att. esagonale 1/4"
 - seghetto 260 mm + 7 lame
 - set 9 chiavi a "L" esagonali con testa sferica: 1,5 - 2 - 2,5 - 3 - 4 - 5 - 6 - 8 - 10 mm
 - chiavi a forchetta doppie, cromate satinare:
 - 6x7 - 8x9 - 10x11 - 12x13 - 14x15 - 16x17 - 18x19 - 20x22 mm
 - martello, 300 g
- cassetta in alluminio dimensioni: 425 x 350 x 235 mm

RICAMBI

BGS articolo	DESCRIZIONE	Euro
BGS 2204-LEER	CASSETTA VUOTA	88,40

SET 1/2"



**LA PIU' IMITATA
LA PIU' VENDUTA**

PROMO



**BUSSOLE
ESAGONALI**



1/4"
1/2"



articolo

DESCRIZIONE

Euro

24128

**VALIGETTA CON UTENSILI PROFESSIONALI +
BUSSOLE DA 1/4" + 1/2"
IDEALE PER ASSISTENZA E MANUTENZIONE**

320,00

CARATTERISTICHE

- Valigetta in alluminio - 460x330x150 mm
- 13 Bussole da 1/2": 12, 13, 14, 15, 16, 17, 18, 19, 21, 24, 27, 30, 32 mm
- 1 Cricchetto da 1/2"
- 2 Prolunghe da 1/2": 125, 250 mm
- 1 Leva con quadro scorrevole da 1/2"
- 2 Snodi - 1/2", 1/4"
- 13 Bussole da 1/4": 4, 4,5, 5, 5,5, 6, 7, 8, 9, 10, 11, 12, 13, 14 mm
- 1 Cricchetto da 1/4"
- 2 Prolunghe da 1/4" (50, 100 mm)
- 1 Leva con quadro scorrevole da 1/4"
- 1 Calibro
- 1 Martello
- 1 Flessometro
- 9 Chiavi combinate - 8, 10, 11, 12, 13, 15, 17, 19, 21 mm
- 9 Brugole a L con testa sferica: 1,5, 2, 2,5, 3, 4, 5, 6, 8, 10 mm
- 1 Chiave inglese
- 2 Pinze + 1 Giratubi + 2 Tronchesi
- 1 Forbici
- 4 Cacciaviti - Taglio 5 e 6, PH 1 e 2
- 1 Pinza per Seeger + 2 Ricambi
- 1 Livella
- 1 Cutter
- 1 Seghetto + 3 Lame per seghetto
- 1 Cricchetto per inserti
- 30 Inserti:
Taglio: 3, 4, 5, 5, 7 mm
Esagonali: 3, 4, 5, 6 mm
PH: 1, 2, 3, 4
PZ: 1, 2, 3, 4
Torx: T10, 15, 20, 25, 30, 35, 40
Torx con foro: T10, 15, 20, 25, 30, 35, 40
- 1 Box per inserti
- 1 Adattatore per bussole da 1/4"
- 1 Porta inserti a sgancio rapido

RICAMBI



articolo

DESCRIZIONE

Euro

24128-V

VALIGETTA VUOTA IN ALLUMINIO PER 24128

60,90

**VALIGETTA
IN ALLUMINIO
RINFORZATA**

PROMO

**BUSSOLE
SURFACE DRIVE**



1/4"
1/2"

CV

PRO+



articolo

DESCRIZIONE

Euro

BGS 15501

**VALIGETTA PROFESSIONALE IN ALLUMINIO
CON 149 UTENSILI**

560,00

CARATTERISTICHE

- cricchetti reversibili: 1/4 " + 1/2"
- bussole att. 1/4 ", surface drive: 4-4,5-5-5,5-6-7-8-9-10-11-12-13-14 mm
- bussole att. 1/2 ", surface drive: 10-13-14-16-17-18-19-20-22-24-27-30-32 mm
- impugnatura portabussole, att. Quadro maschio 1/4 "
- snodi: 1/4 " + 1/2"
- prolunghe att. 1/4 ": 50 + 100 mm
- prolunghe att. 1/2": 125 + 250 mm
- leva a t con quadro Scorrevole 3/8 " F, 1/2" M
- adattatore portainseri esagonali att. 1/4", att. Quadro 1/4"
- martello tipo tedesco 300 g, manico HICKORY, DIN 1041
- flessometro 5 m, 19 mm
- chiavi a L esagonali, finitura satinata, in supporto pieghevole: 1,5 - 2 - 2,5 - 3 - 4 - 5 - 6 - 8 - 10 mm
- chiavi a L Torx, finitura satinata, in supporto pieghevole: Tx10 - Tx15 - Tx20 - Tx25 - Tx27 - Tx30 - Tx40 - Tx45 - Tx50
- cacciavite:
- PH 1 x 75 mm; PH 2 x 100 mm
- taglio: 5,0 x 0,8 x 75 mm; 6,5 x 1,2 x 100 mm
- impugnatura porta inserti att. 1/4" 200 mm
- box inserti colorati att. 1/4 "
- PZ 1 - 2 - 3; PH 1 - 2 - 3
- Taglio 3 - 4 - 5 - 6 mm
- Torx: Tx10 - Tx15 - Tx20 - Tx25 - Tx27 - Tx30 - Tx40
- Esagono: 3 - 4 - 5 - 6 mm
- Adattatore Portainseri quadro femmina 1/4 " - 1/4" esagonale
- Portainseri gancio rapido
- cutter con lama retrattile da 18 mm
- tester di tensione con clip, 125 - 250V, 140 mm
- livella a bolla a 3 vie, in alluminio
- tenaglia, 250 mm
- pinza regolabile 250 mm, impugnatura bi-componente
- forbici 180 mm, impugnatura bi-componente
- pinze professionali 180 mm, impugnatura bi-componente
- pinze becchi lunghi 160 mm, impugnatura bi-componente
- tronchese taglio diagonale 160 mm
- pinza per crimpare 235 mm
- assortimento 30 terminali
- chiavi combinate, cromate, estremità lucide: 8 - 10 - 11 - 12 - 13-15 - 17 - 19 mm
- chiave a rullino 8 "
- pinza per seeger interni: 165 mm
- pinza per seeger esterni 165 mm
- 260 mm Sega, lame 150 millimetri
- 150 mm lame, 3 pezzi

valigetta in alluminio rinforzata

RICAMBI



articolo

DESCRIZIONE

Euro

BGS 15501-LEER

VALIGETTA VUOTA PER SET BGS 15501

162,38



NEW POLLICI

NEW



BUSSOLE ESAGONALI

BUSSOLE ESAGONALI



BGS articolo	DESCRIZIONE	Euro
BGS 9192	SET 2 CASSETTE, 174 CHIAVI A BUSSOLA ESAGONALI, ATT. 1/4" + 1/2"	172,90

BGS articolo	DESCRIZIONE	Euro
BGS 9192	SET 2 CASSETTE, 174 CHIAVI A BUSSOLA ESAGONALI MISURE IN POLLICI, ATT. 1/4" + 1/2"	172,90

CARATTERISTICHE

- comprende due set attacco 1/4" e 1/2"
- comprende i seguenti utensili attacco 1/4":
 - cricchetto reversibile, 72 denti, con pulsante di sgancio rapido
 - prolunga, 50 mm
 - leva con quadro scorrevole
 - impugnatura 150 mm
 - bussole esagonali: 4-4.5-5-5.5-6-7-8-9-10-11-12-13-14 mm
 - 1 adattatore portainseriti 1/4" esagonale
 - inserti attacco esagonale 1/4", lunghezza 50 mm: PZ1-PZ2 - Taglio 4 e 6 mm
 - inserto speciale per viti a occhio
 - inserti esagonali in pollici, attacco 1/4": 1/16"-5/64"-3/32"-7/64"-1/8"-9/64"-5/32"-3/16"-7/32"-1/4"
 - inserti esagonali con foro in pollici, attacco 1/4": 5/64"-3/32"-7/64"-1/8"-9/64"-5/62"
 - inserti esagonali metrici, attacco 1/4": 1.5-2-2.5-3-4-5-5.5-6-8 mm
 - inserti esagonali metrici con foro, attacco 1/4": 2-2.5-3-4-5-6 mm
 - inserti spanner, attacco 1/4": 4-6-8-10 mm
 - inserti Torx, attacco 1/4": TX8-TX10-TX15-TX20-TX25-TX27-TX30-TX35-TX40
 - inserti Torx con foro, attacco 1/4": TH8-TH10-TH15-TH20-TH25-TH27-TH30-TH35-TH40
 - inserti xzn, attacco 1/4": 5-6-8
 - inserti Quadro, attacco 1/4": S0-S1-S2-S3
 - inserti PZ, attacco 1/4": PZ0-PZ0-PZ1-PZ1-PZ2-PZ2-PZ2-PZ2-PZ3-PZ3
 - inserti PH, attacco 1/4": PH0-PH0-PH1-PH1-PH2-PH2-PH2-PH3-PH3
 - inserti Taglio, attacco 1/4": 3-4-4.5-5-5.5-6-6.5-7-8 mm
 - inserti a due tacche, attacco 1/4": C1-C2-C3
 - inserti Tri-wing, attacco 1/4": 1-2-3-4-6-8-10
 - chiavi a L esagonali: 1-1.5-2-2.5-3-4-5 mm
- comprende i seguenti utensili attacco 1/2":
 - cricchetto reversibile, 72 denti, con pulsante di sgancio rapido
 - prolunghie: 125, 200 mm
 - adattatore quadro scorrevole per uso come leva a T
 - snodo
 - bussole esagonali: 10-11-12-13-14-15-16-17-18-19-20-21-22-24-27-30-32 mm
 - inserti attacco 5/16" (8 mm): PH3-PH4 / PZ3-PZ4
 - Taglio: 8-10-12
 - Torx: TX40-TX45-TX50-TX55-TX60
 - Torx con foro: TH40-TH45-TH50-TH55-TH60
 - XZN: M8-M10-M12
 - Esagono: 7-8-10-12 mm

CARATTERISTICHE

- comprende due set attacco 1/4" e 1/2"
- comprende i seguenti utensili attacco 1/4":
 - cricchetto reversibile, 72 denti, con pulsante di sgancio rapido
 - prolunga, 50 mm
 - leva con quadro scorrevole
 - impugnatura 150 mm
 - bussole esagonali in pollici: 5/32-3/16-7/32-1/4-9/32-5/16-11/32-3/8-13/32-7/16-15/32-1/2-9/16"
 - 1 adattatore portainseriti 1/4" esagonale
 - inserti attacco esagonale 1/4", lunghezza 50 mm: PZ1-PZ2 - Taglio 4 e 6 mm
 - inserto speciale per viti a occhio
 - inserti esagonali in pollici, attacco 1/4": 1/16"-5/64"-3/32"-7/64"-1/8"-9/64"-5/32"-3/16"-7/32"-1/4"
 - inserti esagonali con foro in pollici, attacco 1/4": 5/64"-3/32"-7/64"-1/8"-9/64"-5/62"
 - inserti esagonali metrici, attacco 1/4": 1.5-2-2.5-3-4-5-5.5-6-8 mm
 - inserti esagonali metrici con foro, attacco 1/4": 2-2.5-3-4-5-6 mm
 - inserti spanner, attacco 1/4": 4-6-8-10 mm
 - inserti Torx, attacco 1/4": TX8-TX10-TX15-TX20-TX25-TX27-TX30-TX35-TX40
 - inserti Torx con foro, attacco 1/4": TH8-TH10-TH15-TH20-TH25-TH27-TH30-TH35-TH40
 - inserti xzn, attacco 1/4": 5-6-8
 - inserti Quadro, attacco 1/4": S0-S1-S2-S3
 - inserti PZ, attacco 1/4": PZ0-PZ0-PZ1-PZ1-PZ2-PZ2-PZ2-PZ2-PZ3-PZ3
 - inserti PH, attacco 1/4": PH0-PH0-PH1-PH1-PH2-PH2-PH2-PH3-PH3
 - inserti Taglio, attacco 1/4": 3-4-4.5-5-5.5-6-6.5-7-8 mm
 - inserti a due tacche, attacco 1/4": C1-C2-C3
 - inserti Tri-wing, attacco 1/4": 1-2-3-4-6-8-10
 - chiavi a L esagonali: 1-1.5-2-2.5-3-4-5 mm
- comprende i seguenti utensili attacco 1/2":
 - cricchetto reversibile, 72 denti, con pulsante di sgancio rapido
 - prolunghie: 125, 200 mm
 - adattatore quadro scorrevole per uso come leva a T
 - snodo
 - bussole esagonali in pollici: 3/8"-7/16"-15/32"-1/2"-9/16"-19/32"-5/8"-11/16"-23/32"-3/4"-7/8"
 - inserti attacco 5/16" (8 mm): PH3-PH4 / PZ3-PZ4
 - Taglio: 8-10-12
 - Torx: TX40-TX45-TX50-TX55-TX60
 - Torx con foro: TH40-TH45-TH50-TH55-TH60
 - XZN: M8-M10-M12
 - Esagono: 7-8-10-12 mm

SET 1/2"



articolo	DESCRIZIONE	Euro
24108	CASSETTA 108 PEZZI, CHIAVI A BUSSOLA SURFACE DRIVE DA 1/4" & 1/2" + BUSSOLE TORX® - CHROM-VANADIUM QUALITÀ EXTRA	115,00

CARATTERISTICHE

- 13 Bussole da 1/4" surface drive: 4, 4.5, 5, 5.5, 6, 7, 8, 9, 10, 11, 12, 13, 14 mm
- 8 Bussole da 1/4" surface drive Lunghe: 6, 7, 8, 9, 10, 11, 12, 13 mm
- 5 Bussole da 1/4" Torx - E4, E5, E6, E8
- 2 Prolunghe da 1/4" - 75, 100 mm
- 1 Impugnatura porta bussole da 1/4"
- 1 Snodo 1/4"
- 1 Leva con quadro scorrevole da 1/4"
- 1 Cricchetto sgancio rapido da 1/4"
- 18 Bussole cromate da 1/4" con inserti:
 - 7 torx: TX8, TX 10, TX 15, TX20, TX25, TX27, TX30
 - 4 esagono - 3, 4, 5, 6 mm
 - 3 taglio - 4, 5.5, 6.5 mm
 - 2 Ph - 1, 2
 - 2 Pz - 1, 2
- 17 Bussole da 1/2" surface drive
 - 10, 11, 12, 13, 14, 15, 16, 17, 18, 19, 20, 21, 22, 24, 27, 30, 32 mm
- 5 Bussole da 1/2" lunghe surface drive: 14, 15, 17, 19, 22 mm
- 8 Bussole da 1/2" Torx: E10, E11, E12, E14, E16, E18, E20, E24
- 1 Cricchetto sgancio rapido da 1/2"
- 2 Prolunghe da 1/2" - 125, 250 mm
- 2 Bussole per candele 1/2": 16, 21 mm
- 1 Snodo da 1/2"
- 1 Quadro scorrevole 1/2"
- 1 Adattatore - Quadro 1/2" - Porta inserti 5/16"
- 17 Inserti 5/16":
 - 5 esagono - 7, 8, 10, 12, 14 mm
 - 3 taglio - 8, 10, 12 mm
 - 2 Ph - 3, 4
 - 2 Pz - 3, 4
 - 5 Torx - T40, T45, T50, T55, T60
- 4 Chiavi maschio esagonali piegate: 1.27, 1.5, 2, 2.5 mm

RICAMBI

articolo	DESCRIZIONE	Euro
24108-V	VALIGETTA VUOTA PER 24108/35108	21,00

articolo	DESCRIZIONE	Euro
BGS 2287	CASSETTA 108 PEZZI, CHIAVI A BUSSOLA SURFACE DRIVE DA 1/4" & 1/2" + BUSSOLE TORX® - CHROM-VANADIUM QUALITÀ EXTRA	165,10

CARATTERISTICHE

- comprende i seguenti utensili attacco 1/4":
 - 13 Bussole da 1/4" surface drive: 4, 4.5, 5, 5.5, 6, 7, 8, 9, 10, 11, 12, 13, 14 mm
 - 8 Bussole da 1/4" surface drive Lunghe: 6, 7, 8, 9, 10, 11, 12, 13 mm
 - 5 Bussole da 1/4" Torx - E4, E5, E6, E7, E8
 - 2 Prolunghe da 1/4" - 50, 100 mm
 - 1 Impugnatura porta bussole da 1/4"
 - 1 Snodo 1/4"
 - 1 Leva con quadro scorrevole da 1/4"
 - 1 Cricchetto sgancio rapido da 1/4"
 - 18 Bussole cromate da 1/4" con inserti:
 - 7 torx: TX8, TX 10, TX 15, TX20, TX25, TX27, TX30
 - 4 esagono - 3, 4, 5, 6 mm
 - 3 taglio - 4, 5.5, 6.5 mm
 - 2 Ph - 1, 2
 - 2 Pz - 1, 2
- comprende i seguenti utensili attacco 1/2":
 - 17 Bussole da 1/2" surface drive
 - 10, 11, 12, 13, 14, 15, 16, 17, 18, 19, 20, 21, 22, 24, 27, 30, 32 mm
 - 5 Bussole da 1/2" lunghe surface drive: 14, 15, 17, 19, 22 mm
 - 8 Bussole da 1/2" Torx: E10, E11, E12, E14, E16, E18, E20, E24
 - 1 Cricchetto sgancio rapido da 1/2"
 - 2 Prolunghe da 1/2" - 125, 250 mm
 - 2 Bussole per candele 1/2": 16, 21 mm
 - 1 Snodo da 1/2"
 - 1 Quadro scorrevole 1/2"
 - 1 Adattatore - Quadro 1/2" - Porta inserti 5/16"
- 17 Inserti 5/16":
 - 5 esagono - 7, 8, 10, 12, 14 mm
 - 3 taglio - 8, 10, 12 mm
 - 2 Ph - 3, 4
 - 2 Pz - 3, 4
 - 5 Torx - T40, T45, T50, T55, T60
- 4 Chiavi maschio esagonali piegate: 1.27, 1.5, 2, 2.5 mm



ESAGONALI

108 PEZZI

BUSSOLE
ESAGONALI



1/4"
1/2"

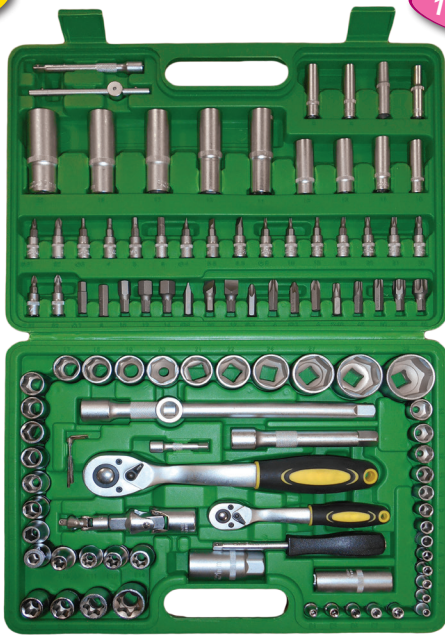

FERMEC
articolo

DESCRIZIONE

Euro

35108

**CASSETTA 108 PEZZI, CHIAVI A BUSSOLA
ESAGONALI DA 1/4" & 1/2"
+ BUSSOLE TORX® - CHROM-VANADIUM
QUALITÀ EXTRA**

120,00

CARATTERISTICHE

- 13 Bussole da 1/4" esagonali: 4, 4.5, 5, 5.5, 6, 7, 8, 9, 10, 11, 12, 13, 14 mm
- 8 Bussole da 1/4" esagonali Lunghe: 6, 7, 8, 9, 10, 11, 12, 13 mm
- 5 Bussole da 1/4" Torx - E4, E5, E6, E8
- 2 Prolunghe da 1/4" - 75, 100 mm
- 1 Impugnatura porta bussole da 1/4"
- 1 Snodo 1/4"
- 1 Leva con quadro scorrevole da 1/4"
- 1 Cricchetto sgancio rapido da 1/4"
- 18 Bussole cromate da 1/4" con inserti:
 - 4 esagono - 3, 4, 5, 6 mm
 - 3 taglio - 4, 5.5, 6.5 mm
 - 2 Ph - 1, 2
 - 2 PZ - 1, 2
- 7 Torx: T8, T10, T15, T20, T25, T27, T30
- 17 Bussole da 1/2" esagonali
10, 11, 12, 13, 14, 15, 16, 17, 18, 19, 20, 21, 22, 24, 27, 30, 32 mm
- 5 Bussole da 1/2" lunghe esagonali: 14, 15, 17, 19, 22 mm
- 8 Bussole da 1/2" Torx: E10, E11, E12, E14, E16, E18, E20, E24
- 1 Cricchetto sgancio rapido da 1/2"
- 2 Prolunghe da 1/2" - 125, 250 mm
- 2 Bussole per candele 1/2": 16, 21 mm
- 1 Snodo da 1/2"
- 1 Quadro scorrevole 1/2"
- 1 Adattatore - Quadro 1/2" - Porta inserti 5/16"
- 17 Inserti 5/16":
 - 5 esagono - 7, 8, 10, 12, 14 mm
 - 3 taglio - 8, 10, 12 mm
 - 2 Ph - 3, 4
 - 2 Pz - 3, 4
 - 5 Torx - T40, T45, T50, T55, T60
- 4 Chiavi maschio esagonali piegate: 1.27, 1.5, 2, 2.5 mm

ESAGONALI

PROMO



1/4"-3/8"-1/2"

CV



BUSSOLE
ESAGONALI



BGS
articolo

DESCRIZIONE

Euro

BGS 15216

**CASSETTA 216 PEZZI, CHIAVI A BUSSOLA
ESAGONALI DA 1/4" - 3/8" - 1/2"
+ CHIAVI COMBinate 8-19 MM**

230,00

CARATTERISTICHE

- comprende i seguenti utensili con attacco 1/2":
 - cricchetto reversibile
 - 2 x prolunghe: 125, 250 mm
 - quadro scorrevole per prolunghe
 - snodo
 - 2 x bussole per candele: 16, 21 mm
 - riduzione da 3/8" a 1/2"
 - 14 x bussole Esagonali : 13-14-15-16-17-18-19-20-21-22-24-27-30-32 mm
 - 5 x bussole Esagonali lunghe: 16-17-19-21-22 mm
 - 3 x bussole Torx femmina: E20 - E22 - E24
 - bussola Torx maschio Tx-70
 - bussola Esagono maschio 14 mm
- comprende i seguenti utensili con attacco 3/8":
 - cricchetto reversibile
 - prolunga 125 mm
 - snodo
 - bussola per candele 18 mm
 - quadro scorrevole per prolunghe
 - 10 x bussole Esagonali: 10-11-12-13-14-15-16-17-18-19 mm
 - 6 x bussole Esagonali lunghe: 10-11-12-13-14-15 mm
 - 7 x bussole Torx femmina: E10- E12- E14- E16- E18
- comprende i seguenti utensili con attacco 1/4":
 - cricchetto reversibile
 - prolunghe: 50, 100 mm
 - snodo
 - chiave a T con quadro scorrevole
 - impugnatura portabussole
 - 13 x bussole Esagonali: 4-4.5-5-5.5-6-7-8-9-10-11-12-13-14 mm
 - 7 x bussole Esagonali lunghe: 4-5-6-7-8-9-10
 - 5 x bussole Torx femmina: E4 - E5 - E6 - E7 - E8
 - 30 x bussole maschio: Torx, Torx con foro, PH, PZ, Esagono, Taglio
 - 30 x inserti att. 10 mm
 - 44 x inserti att. 1/4"
 - adattatore portabussole
 - adattatori portainseriti
- 12x chiavi combinate: 8 - 19 mm
- 7x chiavi a L esagonali: 1.2 - 5 mm
- impugnatura portainseriti

RICAMBI

BGS
articolo

DESCRIZIONE

Euro

BGS 15216-1

VALIGETTA VUOTA PER SET BGS 15216

29,33

SET 1/2"

PROMO

NEW PROMO



BSG articolo	DESCRIZIONE	Euro
BSG 15217	CASSETTA 176 PEZZI, CHIAVI A BUSSELA SURFACE DRIVE DA 1/4" - 3/8" - 1/2" + CHIAVI COMBinate A CRICCHETTO 8-19 MM	286,00

CARATTERISTICHE

- comprende i seguenti utensili attacco 1/4":
 - cricchetto reversibile 72 denti
 - 13 bussole: 4-4,5-5-5,5-6-7-8-9-10-11-12-13-14 mm
 - 7 bussole lunghe: 4-5-6-7-8-9-10 mm
 - 5 bussole Torx femmina: E4-E5-E6-E7-E8
 - prolunghe: 50, 100 mm
 - snodo
 - impugnatura 150 mm
 - leva con quadro scorrevole
 - 33 bussole con maschio:
 - Taglio: 4,0-5,5-6,5-7,0 mm
 - Croce: PH: 0-1-2, PZ: 0-1-2
 - Esagono: 3-4-5-6 mm
 - Torx: TX8-TX9-TX10-TX15-TX20-TX25-TX27-TX30
 - Torx c/foro: TH8-TH9-TH10-TH15-TH20-TH25-TH27-TH30
 - XZN: M8-M10-M12
- comprende i seguenti utensili attacco 3/8":
 - cricchetto reversibile 72 denti
 - 10 bussole: 10-11-12-13-14-15-16-17-18-19 mm
 - 6 bussole lunghe: 10-11-12-13-14-15 mm
 - 5 bussole Torx femmina: E10-E11-E12-E14-E16
 - prolunga: 125 mm
 - snodo
 - adattatore portainseriti per inserti 5/16" (8 mm)
- comprende i seguenti utensili attacco 1/2":
 - cricchetto reversibile 72 denti
 - 17 bussole: 10-11-12-13-14-15-16-17-18-19-20-21-22-24-27-30-32 mm
 - 2 bussole lunghe: 16-18 mm
 - 3 bussole Torx femmina: E18-E20-E24
 - prolunga: 125 mm
 - prolunga: 250 mm con quadro scorrevole per uso come leva a T
 - snodo
 - bussole per candele 16-18-21 mm
 - adattatore portainseriti per inserti 5/16" (8 mm)
 - bussole ricoperte per cerchi in lega: 17 - 19-21 mm
- inserti attacco 5/16":
 - 3 Inserti Taglio: 8 -10-12 mm
 - 6 inserti Torx: TX40-TX45-TX50-TX55-TX60-TX70
 - 6 inserti Torx c/foro: TH40-TH45-TH50-TH55-TH60-TH70
 - Croce: PH: 3-4, PZ: 3-4
 - Esagonali: 7-8-10-12-14 mm
- chiavi a L:
 - 9 Torx c/ foro: TH10-TH15-TH20-TH25-TH27-TH30-TH40-TH45-TH50
 - 9 Esagonali: 1,5-2-2,5-3-4-5-6-8-10 mm
- 12 chiavi combinate a cricchetto:**
8-9-10-11-12-13-14-15-16-17-18-19 mm

RICAMBI

BSG articolo	DESCRIZIONE	Euro
BSG 15217-1	VALIGETTA VUOTA PER SET BGS 15217	30,00

PROMO



BUSSOLE MULTIMPRONTA

1/4"
3/8"
1/2"



articolo	DESCRIZIONE	Euro
24276	CASSETTA 176 PEZZI, CHIAVI A BUSSELA MULTIMPRONTA DA 1/4" - 3/8" - 1/2" + CHIAVI COMBinate A CRICCHETTO 8-19 MM	320,00

CARATTERISTICHE

- 13 Bussole da 1/4" MULTIMPRONTA SPLINE DRIVE: 4, 4,5, 5, 5,5, 6, 7, 8, 9, 10, 11, 12, 13, 14 mm
- 7 Bussole da 1/4" Lunghe MULTIMPRONTA SPLINE DRIVE: 4, 5, 6, 7, 8, 9, 10 mm
- 5 Bussole da 1/4" Torx - E4, E5, E6, E7, E8
- 1 Prolunga da 1/4" 50 mm
- 1 Prolunga da 1/4" testa sferica 100 mm
- 1 Cricchetto sgancio rapido da 1/4" 72 denti
- 1 Impugnatura porta bussole da 1/4"
- 1 Snodo 1/4"
- 1 Leva con quadro scorrevole da 1/4"
- 33 Bussole con inserto da 1/4":
 - 4 Brugola 3, 4, 5, 6 mm
 - 4 Taglio 4, 5,5, 6,5, 7 mm
 - 3 XZN M8, M10, M12
 - 3 PH 0, 1, 2; 3
 - PZ 0, 1, 2
 - 8 Torx TX8, TX9, TX10, TX15, TX20, TX25, TX27, TX30
 - 8 Torx con Foro TH8, TH9, TH10, TH15, TH20, TH25, TH27, TH30
- Serie 9 Chiavi a L Torx con foro T10, T15, T20, T25, T27, T30, T40, T45, T50
- Serie 9 Chiavi a L Brugola con testa sferica 1,5, 2, 2,5, 3, 4, 5, 6, 8, 10 mm
- 10 Bussole da 3/8" MULTIMPRONTA - SPLINE: 10, 11, 12, 13, 14, 15, 16, 17, 18, 19 mm
- 6 Bussole da 3/8" Lunghe MULTIMPRONTA SPLINE DRIVE: 10, 11, 12, 13, 14, 15 mm
- 6 Bussole da 3/8" Torx - E10, E11, E12, E14, E16, E18
- 1 Cricchetto sgancio rapido da 3/8" 72 denti
- 1 Prolunga da 3/8" testa sferica 125 mm
- 1 Snodo 3/8"
- 1 Bussole per candele 3/8" 18 mm
- 1 Adattatore Quadro 3/8" - Porta inserti 5/16"
- 24 Inserti 5/16" lunghi 30 mm:
 - Taglio 8, 10, 12 mm
 - Ph 3, 4
 - Pz 3, 4
 - Brugola 7, 8, 10, 12, 14 mm
 - Torx T40, T45, T50, T55, T60, T70
 - Torx con foro T40, T45, T50, T55, T60, T70
- 17 Bussole da 1/2" MULTIMPRONTA - SPLINE: 10, 11, 12, 13, 14, 15, 16, 17, 18, 19, 20, 21, 22, 24, 27, 30, 32 mm
- 2 Bussole da 1/2" lunghe MULTIMPRONTA - SPLINE (16, 18 mm)
- 2 Bussole da 1/2" Torx (E20, E24)
- 3 Bussole da 1/2" Impact con rivestimento in plastica: 17, 19, 21 mm
- 1 Cricchetto sgancio rapido da 1/2" 72 denti
- 1 Prolunga da 1/2" 125 mm
- 1 Prolunga da 1/2" testa sferica 250 mm
- 2 Bussole per candele 1/2" 16, 21 mm
- 1 Adattatore - Quadro 1/2" - Porta inserti 5/16"
- 12 Chiavi Combinate a cricchetto 8, 9, 10, 11, 12, 13, 14, 15, 16, 17, 18, 19 mm



BGS articolo	DESCRIZIONE	Euro
BGS 8820	CASSETTA 218 PEZZI, CHIAVI A BUSSOLA SURFACE DRIVE DA 1/4" - 3/8" - 1/2" + CHIAVI COMBinate A CRICCHETTO 8-19 MM	535,00

BGS articolo	DESCRIZIONE	Euro
BGS 2290	CASSETTA 218 PEZZI, CHIAVI A BUSSOLA MULTIMPRONTA DA 1/4" - 3/8" - 1/2" + CHIAVI COMBinate A CRICCHETTO 8-19 MM	535,00

CARATTERISTICHE

CARATTERISTICHE

- comprende i seguenti utensili attacco 1/4":
 - cricchetto reversibile
 - 13 bussole: 4 - 4,5 - 5 - 5,5 - 6 - 7 - 8 - 9 - 10 - 11 - 12 - 13 - 14 mm
 - 7 bussole lunghe: 4 - 5 - 6 - 7 - 8 - 9 - 10 mm
 - 5 bussole Torx femmina: E4 - E5 - E6 - E7 - E8
 - prolunghe: 50, 100 mm
 - snodo
 - impugnatura 150 mm
 - leva con quadro scorrevole
 - 33 bussole con maschio:
 - Taglio: 4,0 - 5,5 - 6,5 - 7,0 mm
 - Croce: PH: 0 - 1 - 2, PZ: 0 - 1 - 2
 - Esagono: 3 - 4 - 5 - 6 mm
 - Torx: TX8 - TX9 - TX10 - TX15 - TX20 - TX25 - TX27 - TX30
 - Torx c/foro: TH8 - TH9 - TH10 - TH15 - TH20 - TH25 - TH27 - TH30
 - XZN: M8 - M10 - M12
- comprende i seguenti utensili attacco 3/8":
 - cricchetto reversibile
 - 10 bussole: 10-11-12-13-14-15-16-17-18-19 mm
 - 6 bussole lunghe: 10-11-12-13-14-15 mm
 - 6 bussole Torx femmina: E10 - E11 - E12 - E14 - E16 - E18
 - prolunga: 125 mm
 - snodo
 - bussola per candele 18 mm
 - adattatore portainseriti per inserti 5/16" (8 mm)
- comprende i seguenti utensili attacco 1/2":
 - cricchetto reversibile
 - 17 bussole: 10-11-12-13-14-15-16-17-18-19-20-21-22-24-27-30-32 mm
 - 2 bussole lunghe: 16-18 mm
 - 2 bussole Torx femmina: E20-E24
 - prolunga: 125 mm
 - prolunga: 250 mm con quadro scorrevole per uso come leva a T
 - snodo
 - bussole per candele 16 - 21 mm
 - adattatore portainseriti per inserti 5/16" (8 mm)
 - bussole ricoperte per cerchi in lega: 17- 19 - 21 mm
- inserti attacco 5/16:
 - 6 inserti Torx: TX40 - TX45 - TX50 - TX55 - TX60 - TX70
 - 6 inserti Torx c/foro: TH40 - TH45 - TH50 - TH55 - TH60 - TH70
 - Croce: PH: 3 - 4, PZ: 3 - 4
 - Esagonali: 7-8-10-12-14 mm
- chiavi a L:
 - 9 Torx c/ foro: TH10 - TH15 - TH20 - TH25 - TH27 - TH30 - TH40 - TH45 - TH50
 - 9 Esagonali: 1,5 - 2 - 2,5 - 3 - 4 - 5 - 6 - 8 - 10 mm
- 12 chiavi combinate a cricchetto: 8-9-10-11-12-13-14-15-16-17-18-19 mm

- comprende i seguenti utensili attacco 1/4":
 - cricchetto reversibile 72 denti
 - 13 bussole: 4 - 4,5 - 5 - 5,5 - 6 - 7 - 8 - 9 - 10 - 11 - 12 - 13 - 14 mm
 - 7 bussole lunghe: 4 - 5 - 6 - 7 - 8 - 9 - 10 mm
 - 5 bussole Torx femmina: E4 - E5 - E6 - E7 - E8
 - prolunghe: 50, 100 mm
 - snodo
 - impugnatura 150 mm
 - leva con quadro scorrevole
 - 33 bussole con maschio:
 - Taglio: 4,0 - 5,5 - 6,5 - 7,0 mm
 - Croce: PH: 0 - 1 - 2, PZ: 0 - 1 - 2
 - Esagono: 3 - 4 - 5 - 6 mm
 - Torx: TX8 - TX9 - TX10 - TX15 - TX20 - TX25 - TX27 - TX30
 - Torx c/foro: TH8 - TH9 - TH10 - TH15 - TH20 - TH25 - TH27 - TH30
 - XZN: M8 - M10 - M12
- comprende i seguenti utensili attacco 3/8":
 - cricchetto reversibile 72 denti
 - 10 bussole: 10-11-12-13-14-15-16-17-18-19 mm
 - 6 bussole lunghe: 10-11-12-13-14-15 mm
 - 5 bussole Torx femmina: E10 - E11 - E12 - E14 - E16
 - prolunga: 125 mm
 - snodo
 - adattatore portainseriti per inserti 5/16" (8 mm)
- comprende i seguenti utensili attacco 1/2":
 - cricchetto reversibile 72 denti
 - 17 bussole: 10-11-12-13-14-15-16-17-18-19-20-21-22-24-27-30-32 mm
 - 2 bussole lunghe: 16-18 mm
 - 3 bussole Torx femmina: E18 - E20 - E24
 - prolunga: 125 mm
 - prolunga: 250 mm con quadro scorrevole per uso come leva a T
 - snodo
 - bussole per candele 16 - 18 - 21 mm
 - adattatore portainseriti per inserti 5/16" (8 mm)
 - bussole ricoperte per cerchi in lega: 17- 19 - 21 mm
- inserti attacco 5/16:
 - 3 Inserti Taglio: 8 - 10 - 12 mm
 - 6 inserti Torx: TX40 - TX45 - TX50 - TX55 - TX60 - TX70
 - 6 inserti Torx c/foro: TH40 - TH45 - TH50 - TH55 - TH60 - TH70
 - Croce: PH: 3 - 4, PZ: 3 - 4
 - Esagonali: 7-8-10-12-14 mm
- chiavi a L:
 - 9 Torx c/ foro: TH10 - TH15 - TH20 - TH25 - TH27 - TH30 - TH40 - TH45 - TH50
 - 9 Esagonali: 1,5 - 2 - 2,5 - 3 - 4 - 5 - 6 - 8 - 10 mm
- 12 chiavi combinate a cricchetto: 8-9-10-11-12-13-14-15-16-17-18-19 mm

BGS articolo	DESCRIZIONE	Euro
BGS 8820-LEER	VALIGETTA VUOTA PER SET BGS 88200	42,08

BGS articolo	DESCRIZIONE	Euro
BGS 2290-LEER	VALIGETTA VUOTA PER SET BGS 2290	63,75

SET 1/2"

ESAGONALI
**IDEALE PER
ASSISTENZA E
MANUTENZIONE
AUTOMOTIVE**

 1/4"
 3/8"
 1/2"

CV
PRO +

BGS

articolo

DESCRIZIONE
Euro
BGS 2259
**CASSETTA 213 PEZZI, CHIAVI A BUSSOLA
ESAGONALI DA 1/4" - 3/8" - 1/2"
+ CHIAVI COMBinate A CRICCHETTO 8-19 MM**
597,50
CARATTERISTICHE

- comprende i seguenti utensili attacco 1/4":
 - cricchetto reversibile
 - 13 bussole: 4 - 4,5 - 5 - 5,5 - 6 - 7 - 8 - 9 - 10 - 11 - 12 - 13 - 14 mm
 - 7 bussole lunghe: 4 - 5 - 6 - 7 - 8 - 9 - 10 mm
 - 5 bussole Torx femmina: E4 - E5 - E6 - E7 - E8
 - prolunghe: 50, 100 mm
 - snodo
 - impugnatura 150 mm
 - leva con quadro scorrevole
 - adattatore portainseriti per inserti att. 1/4"
 - bussole con maschio
- comprende i seguenti utensili attacco 3/8":
 - cricchetto reversibile 72 denti
 - 10 bussole: 10-11-12-13-14-15-16-17-18-19 mm
 - 6 bussole lunghe: 10-11-12-13-14-15 mm
 - 5 bussole Torx femmina: E10 - E11 - E12 - E14 - E16 - E18
 - prolunga: 125 mm
 - snodo
 - adattatore portainseriti per inserti 5/16" (8 mm) e 10 mm
 - bussola per candele: 18 mm
- comprende i seguenti utensili attacco 1/2":
 - cricchetto reversibile 72 denti
 - 17 bussole: 10-11-12-13-14-15-16-17-18-19-20-21-22-24-27-30-32 mm
 - 2 bussole lunghe: 16-17-18-19-22 mm
 - 3 bussole Torx femmina: E20 - E24
 - prolunga: 125, 250 mm
 - quadro scorrevole per uso come leva a T di prolunghe
 - snodo
 - bussole per candele: 16 - 21 mm
 - adattatore portainseriti per inserti 10 e 14 mm
- inserti attacco 14 mm:
 - inserti Torx: TX70 x 30 mm - TX70 x 115 mm
 - inserti Torx c/foro: TH70 x 30 mm
 - XZN: M14 x 40 mm - M14 x 115 mm
 - Esagonali: 14 mm x 30 mm - 13 mm x 115 mm
- inserti attacco 10 mm:
 - inserti Torx + Torx c/ foro: T55 - T60
 - Esagonali: 10-12 mm
- inserti attacco 5/16":
 - 3 Inserti Taglio: 8 - 10 - 12 mm
 - inserti Torx + Torx c/ foro: T40 - T45 - T50
 - Croce: PH: 3 - 4, PZ: 3 - 4
 - Esagonali: 7-8 mm
- inserti attacco 1/4":
 - Torx: TX5-TX6-TX7
 - Torx c/ foro: TH7
 - 5 Ribe: M5-M6-M7-M8-M9
 - 3 XZN: M5-M6-M8
 - 5 Punte con foro: TS10-TS15-TS20-TS25-TS27-TS30-TS40-TS45-TS50
 - Esagonali: 2-2,5 mm
- chiavi a L Esagonali: 1,27 - 1,5 - 2 - 2,5 - 3 - 4 - 5 mm
- chiavi combinate: 8-9-10-12-13-14-17-19 mm

 1/4"
 1/2"

**IDEALE PER
ASSISTENZA E
MANUTENZIONE
AUTOMOTIVE**

FERMEC
 articolo

DESCRIZIONE
Euro
2608
**CASSETTA CHIAVI A BUSSOLA CON TUTTE LE
IMPRONTE ALL'INTERNO DELLA CASSETTA
INFORMAZIONI SULL'UTILIZZO DELLE CHIAVI
PER OGNI MODELLO DI AUTO**
161,00
CARATTERISTICHE

- n° 6 BUSSOLE TORX
 - TX40 x 140 MM: SEAT, AUDI, VW, SKODA
 - TX45 x 140 MM: OPEL, GM
 - TX50 x 140 MM: FORD, CITROEN, PEUGEOT, RENAULT
 - TX55 x 140 MM: FORD, MERCEDES, OPEL, RENAULT
 - TX60 x 140 MM: FORD, MERCEDES, VW, AUDI, SEAT
 - TX70 x 140 MM: NISSAN, TOYOTA, MAZDA, FORD.
- n° 7 BUSSOLE XZN:
 - M9 X 100 MM: TOYOTA, SEAT, AUDI, VW
 - M10 X 140 MM: MERCEDES, AUDI, VW, SEAT, SKODA, OPEL
 - M12 X 140 MM: MERCEDES, CHRYSLER
 - M14 X 140 MM: FORD, BMW, SEAT, AUDI, VW, SKODA, PORSCHE, ROVER, JEEP, MERCEDES
 - M16 X 100 MM C/FORO: FORD, PORSCHE, SEAT, AUDI, VW, SKODA
 - M18 X 78 MM: SEAT, VW, AUDI
 - M16 X 55 MM C/FORO: SEAT, AUDI, VW, SKODA
- n° 1 ESAGONO TESTA SFERICA
 - H5 X 160 MM: VW GOLF
- n° 4 RIBE:
 - R7 X 240 MM: FIAT, ALFA
 - R8 X 240 MM: FIAT, ALFA
 - R9 X 100 MM: SEAT, AUDI, VW, SKODA
 - R10 X 140 MM: VW, AUDI, SEAT, FIAT
- n° 9 ESAGONO:
 - H10 X 140 MM: MAZDA, MERCEDES, TOYOTA, SEAT, NISSAN, RENAULT
 - H11 X 140 MM: AUDI, VW, SEAT
 - H13 X 140 MM: AUDI, VW, SEAT
 - H7 X 230 MM: FORD, VW, AUDI
 - H14-17-19-22-24 X 50 MM: SEAT, AUDI, VW, SKODA, FORD, FIAT, ALFA, LANCIA, OPEL, MERCEDES, CITROEN, PEUGEOT, RENAULT
- n° 2 TOR X C/FORO:
 - T30 X 300 MM: AIRBAG, VW, AUDI
 - T80 X 100 MM: BMW
- n° 9 5 PUNTE C/FORO ATT. 1/4":
 - TS10-15-20-25-27-30-40-45-50: MERCEDES

ESAGONALI

BUSSOLE
ESAGONALI



1/4"

3/8"

1/2"



CV

PRO +

BGS
articolo

BGS 2243

DESCRIZIONE

**CASSETTA 192 PEZZI, CHIAVI A BUSSOLA
ESAGONALI DA 1/4" - 3/8" - 1/2"**

Euro

249,88

CARATTERISTICHE

- comprende i seguenti utensili attacco 1/4":
 - cricchetto reversibile 72 denti
 - 13 bussole: 4 - 4,5 - 5 - 5,5 - 6 - 7 - 8 - 9 - 10 - 11 - 12 - 13 - 14 mm
 - 7 bussole lunghe: 4 - 5 - 6 - 7 - 8 - 9 - 10 mm
 - 5 bussole Torx femmina: E4 - E5 - E6 - E7 - E8
 - prolunghe: 50, 100 mm
 - snodo
 - impugnatura 150 mm
 - leva con quadro scorrevole
 - adattatore portainseriti per inserti att. 1/4"
 - bussole con maschio:
 - Taglio: 4,0 - 5,5 - 6,5 - 7,0 mm
 - Croce: PH: 0 - 1 - 2, PZ: 0 - 1 - 2
 - Esagono: 3 - 4 - 5 - 6 mm
 - Torx: TX8 - TX9 - TX10 - TX15 - TX20 - TX25 - TX27 - TX30
 - Torx c/foro: TH8 - TH9 - TH10 - TH15 - TH20 - TH25 - TH27 - TH30
- comprende i seguenti utensili attacco 3/8":
 - cricchetto reversibile 72 denti
 - 10 bussole: 10-11-12-13-14-15-16-17-18-19 mm
 - 6 bussole lunghe: 10-11-12-13-14-15 mm
 - 5 bussole Torx femmina: E10 - E11 - E12 - E14 - E16
 - prolunga: 125 mm
 - snodo
 - adattatore portainseriti per inserti 5/16" (8 mm)
 - bussola per candele: 18 mm
- comprende i seguenti utensili attacco 1/2":
 - cricchetto reversibile 72 denti
 - 17 bussole: 10-11-12-13-14-15-16-17-18-19-20-21-22-24-27-30-32 mm
 - 2 bussole lunghe: 16-17-18-19-22 mm
 - 3 bussole Torx femmina: E18 - E20 - E24
 - prolunga: 125, 250 mm
 - quadro scorrevole per uso come leva a T di prolunghe
 - snodo
 - bussole per candele: 16 - 21 mm
 - adattatore portainseriti per inserti 5/16" (8 mm)
- inserti attacco 5/16":
 - 3 Inserti Taglio: 8 - 10 - 12 mm
 - 6 inserti Torx: TX40 - TX45 - TX50 - TX55 - TX60 - TX70
 - 6 inserti Torx c/foro: TH40 - TH45 - TH50 - TH55 - TH60 - TH70
 - Croce: PH: 3 - 4, PZ: 3 - 4
 - Esagonali: 7-8-10-12-14 mm
- inserti attacco 1/4":
 - Torx: TX5-TX6-TX7-TX10-TX15-TX20-TX25-TX27-TX30-TX40
 - Torx c/ foro: TH5-TH6-TH7-TH10-TH15-TH20-TH25-TH27-TH30-TH40
 - 5 Ribe: M5-M6-M7-M8-M9
 - 3 XZN: M5-M6-M8
 - 5 Punte con foro: TS7-TS10-TS15-TS20-TS25-TS27-TS30-TS40-TS45
 - Croce: PH: 3 - 4, PZ: 3 - 4
 - Esagonali: 2-2,5 mm
- chiavi a L Esagonali: 1 - 1,5 - 2 - 2,5 - 3 - 4 - 5 mm

POLIGONALI

BUSSOLE
POLIGONALI



1/4"

3/8"

1/2"



CV

PRO +

BGS
articolo

BGS 2286

DESCRIZIONE

**CASSETTA 192 PEZZI, CHIAVI A BUSSOLA
POLIGONALI DA 1/4" - 3/8" - 1/2"**

Euro

308,75

CARATTERISTICHE

- comprende i seguenti utensili attacco 1/4":
 - cricchetto reversibile 72 denti
 - 13 bussole: 4 - 4,5 - 5 - 5,5 - 6 - 7 - 8 - 9 - 10 - 11 - 12 - 13 - 14 mm
 - 7 bussole lunghe: 4 - 5 - 6 - 7 - 8 - 9 - 10 mm
 - 5 bussole Torx femmina: E4 - E5 - E6 - E7 - E8
 - prolunghe: 50, 100 mm
 - snodo
 - impugnatura 150 mm
 - leva con quadro scorrevole
 - adattatore portainseriti per inserti att. 1/4"
 - bussole con maschio:
 - Taglio: 4,0 - 5,5 - 6,5 - 7,0 mm
 - Croce: PH: 0 - 1 - 2, PZ: 0 - 1 - 2
 - Esagono: 3 - 4 - 5 - 6 mm
 - Torx: TX8 - TX9 - TX10 - TX15 - TX20 - TX25 - TX27 - TX30
 - Torx c/foro: TH8 - TH9 - TH10 - TH15 - TH20 - TH25 - TH27 - TH30
- comprende i seguenti utensili attacco 3/8":
 - cricchetto reversibile 72 denti
 - 10 bussole: 10-11-12-13-14-15-16-17-18-19 mm
 - 6 bussole lunghe: 10-11-12-13-14-15 mm
 - 5 bussole Torx femmina: E10 - E11 - E12 - E14 - E16 - E18
 - prolunga: 125 mm
 - snodo
 - adattatore portainseriti per inserti 5/16" (8 mm)
 - bussola per candele: 18 mm
- comprende i seguenti utensili attacco 1/2":
 - cricchetto reversibile 72 denti
 - 17 bussole: 10-11-12-13-14-15-16-17-18-19-20-21-22-24-27-30-32 mm
 - 2 bussole lunghe: 16-17-18-19-22 mm
 - 3 bussole Torx femmina: E20 - E24
 - prolunga: 125, 250 mm
 - quadro scorrevole per uso come leva a T di prolunghe
 - snodo
 - bussole per candele: 16 - 21 mm
 - adattatore portainseriti per inserti 5/16" (8 mm)
- inserti attacco 5/16":
 - 3 Inserti Taglio: 8 - 10 - 12 mm
 - 6 inserti Torx: TX40 - TX45 - TX50 - TX55 - TX60 - TX70
 - 6 inserti Torx c/foro: TH40 - TH45 - TH50 - TH55 - TH60 - TH70
 - Croce: PH: 3 - 4, PZ: 3 - 4
 - Esagonali: 7-8-10-12-14 mm
- inserti attacco 1/4":
 - Torx: TX5-TX6-TX7
 - 5 Ribe: M5-M6-M7-M8-M9
 - 3 XZN: M5-M6-M8
 - 5 Punte con foro: TS7-TS10-TS15-TS20-TS25-TS27-TS30-TS40-TS45
 - Croce: PH: 3 - 4, PZ: 3 - 4
 - Esagonali: 2-2,5 mm
- chiavi a L Esagonali: 1 - 1,5 - 2 - 2,5 - 3 - 4 - 5 mm

SET 1/2"

POLLICI

NEW



BGS articolo	DESCRIZIONE	Euro
BGS 2245	CASSETTA 192 PEZZI, CHIAVI A BUSSOLA ESAGONALI DA 1/4" - 3/8" - 1/2", IN POLLICI	287,38

CARATTERISTICHE

- chiavi a L Esagonali: 1.27 - 1.5 - 2 - 2.5 - 3 - 4 - 5 mm
- inserti attacco 5/16":
 - Taglio: 8 - 10 - 12 mm
 - PH: PH3 - PH4 - PZ3 - PZ4
 - Esagonali: 9/32"-5/16"-3/8"-15/32"-9/16"
 - Torx: TX 40 - 45 - 50 - 55 - 60 - 70
 - Torx c/ foro: TH 40 - 45 - 50 - 55 - 60 - 70
- inserti attacco 1/4":
 - Torx: TX 5 - 6 - 7 - 10 - 15 - 20 - 25 - 27 - 30 - 40
 - Torx c/foro: TH 7 - 10 - 15 - 20 - 25 - 27 - 30 - 40
 - Ribe: 5 - 6 - 7 - 8 - 9
 - XZN: 5 - 6 - 8
 - 5 Punte con foro: TS 10 - 15 - 20 - 25 - 27 - 30 - 40 - 45
 - PH: PH1 - PH2 - PZ1 - PZ2
 - Esagonali: 2 - 2.5 mm
- comprende i seguenti utensili attacco 1/4":
 - cricchetto reversibile
 - leva con quadro scorrevole
 - prolunghe: 50, 100 mm
 - snodo
 - impugnatura 150 mm
 - bussole: 5/32"-3/16"-3/16"-7/32"-1/4"-9/32"- 5/16"-11/32"-3/8"-7/16"-15/32"-1/2"-9/16"
 - bussole lunghe: 5/32"-3/16"-1/4"-9/32"-5/16"- 11/32"-3/8"
 - 5 bussole Torx femmina: E4 - E5 - E6 - E7 - E8
 - adattatore portainseriti per inserti att. 1/4"
 - bussole con maschio:
 - Torx: TX8-9-10-15-20-25-27-30
 - Torx c/foro: TH8-9-10-15-20-25-27-30
 - Esagonali: 3-4-5-6 mm
 - PH: PH0-PH1-PH2
 - PZ: PZ0-PZ1-PZ2
 - Taglio: 4-5-5-6-5-7 mm
- comprende i seguenti utensili attacco 3/8":
 - cricchetto reversibile
 - prolunga: 125 mm
 - snodo
 - bussola per candele: 18 mm
 - bussole: 3/8"-7/16"-15/32"-1/2"-9/16"-19/32"-5/8"- 11/16"-3/4"-25/32"
 - bussole lunghe: 3/8"-7/16"-15/32"-1/2"-9/16"-19/32"
 - 5 bussole Torx femmina: E10 - E11 - E12 - E14 - E16 - E18
- comprende i seguenti utensili attacco 1/2":
 - cricchetto reversibile
 - prolunga: 125, 250 mm
 - quadro scorrevole per uso come leva a T di prolunghe
 - adattatore portainseriti per inserti 5/16"
 - snodo
 - bussole per candele: 16 - 21 mm
 - 17 bussole: 3/8"-7/16"-15/32"-1/2"-9/16"- 19/32"-5/8"-21/32"-11/16"-3/4"-25/32"-13/16"- 7/8"-15/16"-1-1/16"- 1-3/16"-1-1/4"
 - 2 bussole lunghe: 5/8", 11/16", 3/4", 13/16", 7/8"
 - bussole Torx femmina: E20 - E24

SURFACE DRIVE

BUSSOLE SURFACE DRIVE



1/4"
3/8"
1/2"



BGS articolo	DESCRIZIONE	Euro
BGS 2292	CASSETTA 192 PEZZI, CHIAVI A BUSSOLA SURFACE DRIVE DA 1/4" - 3/8" - 1/2"	249,88

CARATTERISTICHE

- comprende i seguenti utensili attacco 1/4":
 - cricchetto reversibile 72 denti
 - 13 bussole: 4 - 4,5 - 5 - 5,5 - 6 - 7 - 8 - 9 - 10 - 11 - 12 - 13 - 14 mm
 - 7 bussole lunghe: 4 - 5 - 6 - 7 - 8 - 9 - 10 mm
 - 5 bussole Torx femmina: E4 - E5 - E6 - E7 - E8
 - prolunghe: 50, 100 mm
 - snodo
 - impugnatura 150 mm
 - leva con quadro scorrevole
 - adattatore portainseriti per inserti att. 1/4"
 - bussole con maschio
- comprende i seguenti utensili attacco 3/8":
 - cricchetto reversibile 72 denti
 - 10 bussole: 10-11-12-13-14-15-16-17-18-19 mm
 - 6 bussole lunghe: 10-11-12-13-14-15 mm
 - 5 bussole Torx femmina: E10 - E11 - E12 - E14 - E16
 - prolunga: 125 mm
 - snodo
 - adattatore portainseriti per inserti 5/16" (8 mm)
 - bussola per candele: 18 mm
- comprende i seguenti utensili attacco 1/2":
 - cricchetto reversibile 72 denti
 - 17 bussole: 10-11-12-13-14-15-16-17-18-19-20-21-22-24-27-30-32 mm
 - 2 bussole lunghe: 16-17-18-19-22 mm
 - 3 bussole Torx femmina: E18 - E20 - E24
 - prolunga: 125, 250 mm
 - quadro scorrevole per uso come leva a T di prolunghe
 - snodo
 - bussole per candele: 16 - 21 mm
 - adattatore portainseriti per inserti 5/16" (8 mm)
- inserti attacco 5/16":
 - 3 Inserti Taglio: 8 - 10 - 12 mm
 - 6 inserti Torx: TX40 - TX45 - TX50 - TX55 - TX60 - TX70
 - 6 inserti Torx c/foro: TH40 - TH45 - TH50 - TH55 - TH60 - TH70
 - Croce: PH: 3 - 4, PZ: 3 - 4
 - Esagonali: 7-8-10-12-14 mm
- inserti attacco 1/4":
 - 3 Inserti Taglio: 8 - 10 - 12 mm
 - 10 inserti Torx: TX5-TX6-TX7-TX10-TX15-TX20-TX25-TX27-TX30-TX40
 - 8 inserti Torx c/foro: TH7-TH10-TH15-TH20-TH25-TH27-TH30-TH40
 - 5 Ribe: M5-M6-M7-M8-M9
 - 3 XZN: M5-M6-M8
 - 5 Punte con foro: TS10-TS15-TS20-TS25-TS27-TS30-TS40-TS45
 - Croce: PH: 3 - 4, PZ: 3 - 4
 - Esagonali: 2-2.5 mm
- chiavi a L Esagonali: 1 - 1,5 - 2 - 2,5 - 3 - 4 - 5 mm

RICAMBI

BGS articolo	DESCRIZIONE	Euro
BGS 2292-LEER	VALIGETTA VUOTA PER SET BGS 2292	27,80



SURFACE DRIVE

BUSSOLE SURFACE DRIVE



1/4"
3/8"
1/2"

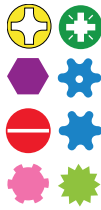

CV



NEW

BGS articolo	DESCRIZIONE	Euro
BGS 2283	CASSETTA 172 PEZZI, CHIAVI A BUSSOLA SURFACE DRIVE DA 1/4" - 3/8" - 1/2"	160,00

CARATTERISTICHE

- comprende i seguenti utensili attacco 1/4":
 - cricchetto reversibile
 - 13 bussole: 4 - 4,5 - 5 - 5,5 - 6 - 7 - 8 - 9 - 10 - 11 - 12 - 13 - 14 mm
 - 7 bussole lunghe: 4 - 5 - 6 - 7 - 8 - 9 - 10 mm
 - 5 bussole Torx femmina: E4 - E5 - E6 - E7 - E8
 - prolunghe: 50, 100 mm
 - snodo
 - impugnatura 150 mm
 - leva con quadro scorrevole
 - adattatore portainseri per inserti att. 1/4"
 - 30 bussole con maschio
- comprende i seguenti utensili attacco 3/8":
 - cricchetto reversibile
 - 10 bussole: 10-11-12-13-14-15-16-17-18-19 mm
 - 6 bussole lunghe: 10-11-12-13-14-15 mm
 - 6 bussole Torx femmina: E10 - E11 - E12 - E14 - E16 - E18
 - prolunga: 125 mm
 - snodo
 - adattatore portainseri per inserti 5/16" (8 mm)
 - bussola per candele: 18 mm
- comprende i seguenti utensili attacco 1/2":
 - cricchetto reversibile
 - 17 bussole: 10-11-12-13-14-15-16-17-18-19-20-21-22-24-27-30-32 mm
 - 2 bussole lunghe: 16-17-18-19-22 mm
 - 2 bussole Torx femmina: E18 - E20 - E24
 - prolunga: 125, 250 mm
 - quadro scorrevole per uso come leva a T di prolunghe
 - snodo
 - bussole per candele: 16 - 21 mm
 - adattatore portainseri per inserti 5/16" (8 mm)
- 24 inserti attacco 5/16":
 - 3 Inserti Taglio: 8 -10 - 12 mm
 - 6 inserti Torx: TX40 - TX45 - TX50 - TX55 - TX60 - TX70
 - 6 inserti Torx c/foro: TH40 - TH45 - TH50 - TH55 - TH60 - TH70
 - Croce: PH: 3 - 4, PZ: 3 - 4
 - Esagonali: 7-8-10-12-14 mm
- 20 inserti attacco 1/4":
 - 3 Inserti Taglio: 8 -10 - 12 mm
 - 10 inserti Torx: TX5-TX6-TX7-TX10-TX15-TX20-TX25-TX27-TX30-TX40
 - 8 inserti Torx c/foro: TH7-TH10-TH15-TH20-TH25-TH27-TH30-TH40
 - 5 Ribe: M5-M6-M7-M8-M9
 - 3 XZN: M5-M6-M8
 - 5 Punte con foro: TS10-TS15-TS20-TS25-TS27-TS30-TS40-TS45
 - Croce: PH: 3 - 4, PZ: 3 - 4
 - Esagonali: 2-2,5 mm
- chiavi a L Esagonali: 1,2 - 5 mm

RICAMBI

BGS articolo	DESCRIZIONE	Euro
BGS 2283-LEER	VALIGETTA VUOTA PER SET BGS 2283	16,58



BUSSOLE MULTIMPRONTA



CV

PRO+



1/4"
3/8"
1/2"

NEW

BGS articolo	DESCRIZIONE	Euro
BGS 2247	CASSETTA 192 PEZZI, CHIAVI A BUSSOLA MULTIMPRONTA DA 1/4" - 3/8" - 1/2"	249,88

CARATTERISTICHE

- bussole "multimpronta" attacco 1/2" adatte per dadi esagonali, poligonali, misure metriche & pollici, quadri, XZN®, TORX®
- utensili conformi DIN
- attacco quadro: 1/4" , 3/8" e 1/2"
- comprende i seguenti utensili attacco 1/4":
 - cricchetto reversibile, 72 denti, con pulsante di sgancio rapido
 - leva con quadro scorrevole
 - prolunghe: 50, 100 mm
 - snodo
 - impugnatura 150 mm
 - 13 bussole "Multimpronta": 4-4,5-5-5,5-6-7-8-9-10-11-12-13-14 mm
 - 7 bussole lunghe "Multimpronta": 4-5-6-7-8-9-10 mm
 - 5 bussole tipo Torx femmina: E4-5-6-7-8
 - 1 adattatore portainseri 1/4" esagonale
 - bussole con maschio
 - PH0-1-2, PZ0-1-2
 - Taglio: 4-5,5-6,5-7 mm
 - Esagono: 3-4-5-6 mm
 - Torx: TX8-TX9-TX10-TX15-TX20-TX25-TX27-TX30
 - Torx con foro: TH8-TH9-TH10-TH15-TH20-TH25-TH27-TH30
- comprende i seguenti utensili attacco 3/8":
 - cricchetto reversibile, 72 denti, con pulsante di sgancio rapido
 - prolunga 125 mm
 - snodo
 - bussola per candele 18 mm
 - 10 bussole "Multimpronta": 10-11-12-13-14-15-16-17-18-19 mm
 - 6 bussole lunghe "Multimpronta": 10-11-12-13-14-15 mm
 - bussole tipo Torx femmina: E10-11-12-14-16
 - adattatore portainseri 5/16" (8 mm)
- comprende i seguenti utensili attacco 1/2":
 - cricchetto reversibile, 72 denti, con pulsante di sgancio rapido
 - prolunghe: 125, 250 mm
 - adattatore quadro scorrevole per uso come leva a T
 - adattatore portainseri 5/16" (8 mm)
 - snodo
 - bussole per candele: 16-21 mm
 - 17 bussole "Multimpronta": 10-11-12-13-14-15-16-17-18-19-20-21-22-24-27-30-32 mm
 - 5 bussole lunghe "Multimpronta": 16-17-18-19-22 mm
 - bussole tipo Torx femmina: E18-20-24
- inserti attacco 5/16" (8 mm):
 - Taglio: 8-10-12 mm
 - PH3-PH4-PZ3-PZ4
 - Esagono: 7-8-10-12-14 mm
 - Torx: TX40-TX45-TX50-TX55-TX60-TX70
 - Torx con foro: TH40-TH45-TH50-TH55-TH60-TH70
- inserti attacco 1/4":
 - Torx: TX5-TX6-TX7-TX10-TX15-TX20-TX25-TX27-TX30-TX40
 - Torx con foro: TH7-TH10-TH15-TH20-TH25-TH27-TH30-TH40
 - RIBE: M5-6-7-8-9, XZN: M5-6-8
 - 5 punte con foro: TS10-TS15-TS20-TS25-TS27-TS30-TS40-TS45
 - PH3-PH4-PZ3-PZ4
 - Esagono: 2-2,5 mm
- 7 chiavi a L: 1-1,5-2-2,5-3-4-5 mm

SET 1/2"



1/4"-3/8"-1/2"-3/4" 1/4"-3/8"-1/2"-3/4"

RACCORDI DI RIDUZIONE CHROM-VANADIUM

attacco: 1/4" - 3/8" - 1/2" - 3/4"

BCS	FEMMINA	MASCHIO		Euro
articolo				
BCS 271	1/4"	3/8"	1	3,15
BCS 269	3/8"	1/4"	1	3,15
BCS 280	3/8"	1/2"	1	3,68
BCS 270	1/2"	3/8"	1	3,68
BCS 272	1/2"	3/4"	1	8,40
BCS 274	3/4"	1/2"	1	8,40

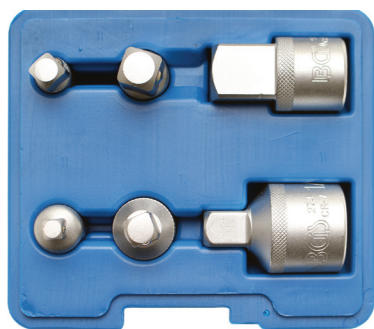

PRO+

CV

BCS	DESCRIZIONE	Euro
articolo		
BCS 199	SET 6 PEZZI ADATTATORI	24,23

CARATTERISTICHE

- cromati satinati

CONTENUTO

- 1/4" F X 3/8" M, coppia massima 60 Nm
- 3/8" F X 1/4" M, coppia massima 60 Nm
- 3/8" F X 1/2" M, coppia massima 200 Nm
- 1/2" F X 3/8" M, coppia massima 200 Nm
- 1/2" F X 3/4" M, coppia massima 500 Nm
- 3/4" F X 1/2" M, coppia massima 500 Nm

RICAMBI

BCS	DESCRIZIONE	Euro
articolo		
BCS 199-LEER	CASSETTA VUOTA	5,36

4x

Steckschlüssel-Adapter-Satz

6.3	1/4"	X	10	3/8"
10	3/8"	X	6.3	1/4"
10	3/8"	X	12.5	1/2"
12.5	1/2"	X	10	3/8"



Tipps
+
Trends

Art. 8808



1/4"-3/8"-1/2"



CV

BCS	DESCRIZIONE	Euro
articolo		
BCS 8808	SET 4 PEZZI, RIDUZIONI	10,25

CARATTERISTICHE

- comprende 4 riduzioni:
 - 1/4" F - 3/8" M
 - 3/8" F - 1/4" M
 - 3/8" F - 1/2" M
 - 1/2" F - 3/8" M
- finitura cromata satinata

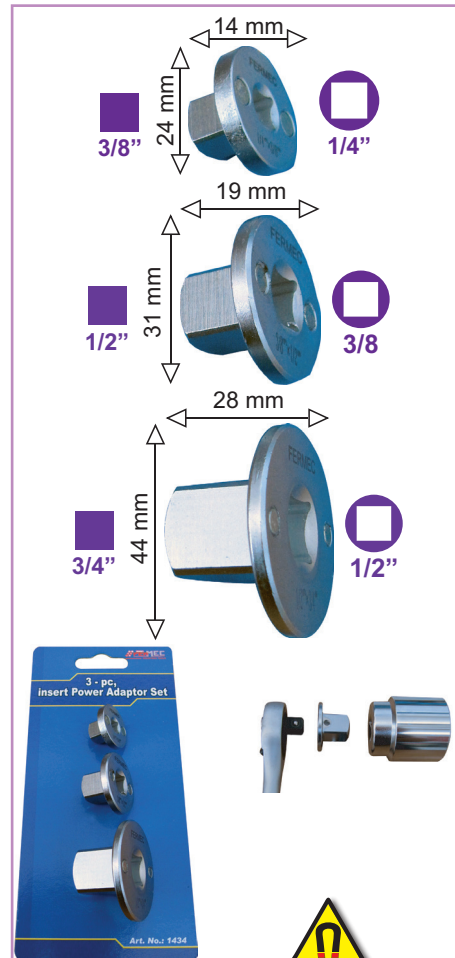

RACCORDI DI RIDUZIONE MAGNETICI A SCOMPARSA IDEALI PER CHIAVI DINAMOMETRICHE E SPAZI RIDOTTI

attacco: 1/4" - 3/8" - 1/2"

FERMEC	FEMMINA	MASCHIO		Euro
articolo				
1434-1/4	1/4"	3/8"	1	8,93
1434-3/8	3/8"	1/2"	1	9,98
1434-1/2	1/2"	3/4"	1	11,03
1434	SET DA 3 PEZZI IN BLISTER		1	28,35





1/2" ESAGONO

BUSSOLE SPECIALI "POWER IMPACT" - CON RIVESTIMENTO ESTERNO E PROTEZIONE INTERNA IN MATERIALE PLASTICO IDEALE PER AVVITARE BULLONI CROMATI DELLE RUOTE DI AUTOVEICOLI CON CERCHI IN LEGA

attacco: 1/2"
impronta: ESAGONO

articolo	mm	L mm		Euro
197-17-LP	17	85	1	10,50
197-19-LP	19	85	1	10,50
197-21-LP	21	85	1	10,50
197-22-LP	22	85	1	11,55
197 LPS	SET 3 PEZZI 17-19-21 mm		1	31,50



1/2" ESAGONO

DESCRIZIONE	Euro
SET 4 PEZZI BUSSOLE RIVESTITE, ATTACCO 1/2"	47,25

CARATTERISTICHE

- lunghezza: 85 mm
- bussole speciali "POWER IMPACT" con rivestimento esterno e protezione interna in materiale plastico
- ideali per avvitare bulloni cromati delle ruote di autoveicoli CON CERCHI IN LEGA
- misure: 17, 19, 21, 22 mm



1/2" ESAGONO

DESCRIZIONE	Euro
SET 5 PEZZI BUSSOLE RIVESTITE, ATT. 1/2"	63,00

CARATTERISTICHE

- lunghezza: 85 mm
- bussole speciali "POWER IMPACT" con rivestimento esterno e protezione interna in materiale plastico
- Ideali per avvitare bulloni cromati delle ruote di autoveicoli CON CERCHI IN LEGA
- misure: 15, 17, 19, 21, 22 mm



CROMO PRO+

DESCRIZIONE	Euro
SET 3 PEZZI, BUSSOLE SPECIALI RICOPERTE ATT. 1/2", 17, 19 E 21 MM	43,10
BGS 7301 17 MM	13,75
BGS 7302 19 MM	13,75
BGS 7303 21 MM	13,75

CARATTERISTICHE

- per uso a mano e a macchina
- ricoperte in plastica per prevenire danni ai cerchi
- con scanalatura e foro per spina
- ogni misura un colore
- lunghezza 85 mm



PRO+

RIVESTIMENTO PLASTICO COLORATO PER BUSSOLE

articolo	mm	Colore		Euro
BGS 7304	17		1	0,89
BGS 7305	19		1	0,89
BGS 7306	21		1	0,89



1/2" ESAGONO

SERIE BUSSOLE SPECIALI RIVESTITE EXTRA LUNGHE 130 MM PER CERCHI IN LEGA PROFONDI

attacco: 1/2"
impronta: ESAGONO

articolo	mm	L mm		Euro
1197-17 LP	17	130	1	17,33
1197-19 LP	19	130	1	17,33
1197-21 LP	21	130	1	17,33
1197-22 LP	22	130	1	17,33
1197 LPS	SET 3 PEZZI 17-19-21 mm		1	51,45



1/2"



ESAGONO

PRO +



CROMO

- BUSSOLA A MACCHINA RIVESTITA IN PLASTICA**
- IDONEE PER UTILIZZO A MANO E A MACCHINA
 - CON COPERTURA IN PLASTICA PER PROTEZIONE DEI CERCHI IN ALLUMINIO
 - CON SCANALATURA E FORO PER SPINA
 - LUNGHEZZA 85 MM

BGS articolo	mm	L mm		Euro
BGS 7207	15	85	1	11,99
BGS 7201	17	85	1	11,99
BGS 7202	19	85	1	12,24
BGS 7203	21	85	1	12,50
BGS 7208	22	85	1	14,54
BGS 7200	SET 3 PEZZI 17-19-21 mm		1	38,12



PRO +

RIVESTIMENTO PLASTICA PER BUSSOLE

BGS articolo	mm		Euro
BGS 7209	15	1	0,89
BGS 7204	17	1	0,89
BGS 7205	19	1	0,89
BGS 7206	21	1	0,89
BGS 7198	22	1	0,77



1/2"

CROMO

PRO +



ESAGONO

BGS articolo	DESCRIZIONE	Euro
BGS 9847	SET 4 PEZZI, BUSSOLE A MACCHINA RIVESTITA IN PLASTICA, ESAGONALI 17-19-21-22MM	47,18

CARATTERISTICHE

- idonee per utilizzo a mano e a macchina
- con scanalatura e foro per spina
- con copertura in plastica per protezione dei cerchi in alluminio
- ogni misura un colore per una più facile identificazione
- lunghezza 85 mm
- misure: 17, 19, 21, 22 mm



1/2"

PRO +

CROMO



ESAGONO

BUSSOLE A MACCHINA RIVESTITA IN PLASTICA EXTRA LUNGHE

- IDONEE PER UTILIZZO A MANO E A MACCHINA
- CON COPERTURA IN PLASTICA PER PROTEZIONE DEI CERCHI IN ALLUMINIO
- CON SCANALATURA E FORO PER SPINA
- LUNGHEZZA 150 MM
- IL SET DA 3 PEZZI È BGS 7100

BGS articolo	mm	L mm		Euro
BGS 7101	17	150	1	29,33
BGS 7102	19	150	1	29,33
BGS 7103	21	150	1	31,88
BGS 7100	SET 3 PEZZI 17-19-21 mm		1	91,67

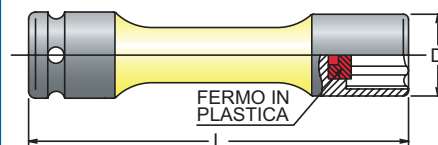
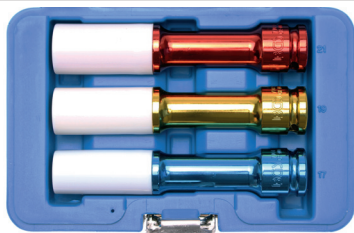

FERMO IN PLASTICA

L

D

ESAGONO

CHIAVI A BUSSOLE BOCCA ESAGONALE COLORATE

Koken articolo	mm	D mm	Colore	L mm		Euro
14145PM-17	17	23.7		110	1	31,74
14145PM-19	19	25.7		110	1	31,74
14145PM-21	21	27.5		110	1	33,44
14145PM-22	22	29		110	1	34,90



Koken articolo	DESCRIZIONE	Euro
14201M	Set 3 pezzi	93,17
CARATTERISTICHE		
14145PM.110	17, 19, 21	





19.35 mm
16.10 mm

1/2" Mercedes-Benz

FERMEC articolo	DESCRIZIONE	Euro
MS17	BUSSOLA PER NUOVI BULLONI RUOTE MERCEDES, LUNGHEZZA 78 MM	11,55

CARATTERISTICHE

- chiave per allentare o avvitare dadi o viti ruote con profilo Socket MS 17. Montate su Mercedes
- diametro: 26 mm
- lunghezza: 78 mm

NEW

BGS 9371

HYUNDAI KIA

1/2" PRO+

BGS articolo	DESCRIZIONE	Euro
BGS 9371	BUSSOLA CON RIVESTIMENTO IN PLASTICA, 21 MM, PER BULLONI HYUNDAI I30, TUCSON & KIA	20,15

CARATTERISTICHE

- bussola rivestita in plastica, particolarmente idonea in presenza di cerchi in alluminio
- adatta per uso con avvitatori

NEW

23mm 5PT

LEXUS PRO+ CV

BGS articolo	DESCRIZIONE	Euro
BGS 9270	BUSSOLA SPECIALE 5 LATI, PER BULLONI DI SICUREZZA TOYOTA E LEXUS	26,78

CARATTERISTICHE

- dimensioni: 23 mm x 5 lati
- anche per uso con avvitatore

19.35 mm
16.10 mm

1/2" Mercedes-Benz

FERMEC articolo	DESCRIZIONE	Euro
MSP17	BUSSOLA CON RIVESTIMENTO IN PLASTICA PER NUOVI BULLONI RUOTE MERCEDES, LUNGHEZZA 78 MM	12,60

CARATTERISTICHE

- chiave per allentare o avvitare dadi o viti ruote con profilo Socket MS 17. Montate su Mercedes
- bussola rivestita in plastica, particolarmente idonea in presenza di cerchi in alluminio
- diametro: 27 mm
- lunghezza: 78 mm

BGS 186 BGS 187

BGS 185-120 BGS 185-135 BGS 185-150

1/2" PRO+

BGS articolo	DESCRIZIONE	Euro
BGS 185	SET BARRE DI TORSIONE DA 5 PEZZI	89,12

CARATTERISTICHE

- 100 - 110 - 120 - 135 - 150 Nm
- lunghezza 195 mm

RICAMBI

BGS articolo	DESCRIZIONE	Euro
BGS 186	NEW 100 Nm	22,10
BGS 187	110 Nm	16,58
BGS 185-120	NEW 120 Nm	22,10
BGS 185-135	NEW 135 Nm	22,10
BGS 185-150	NEW 150 Nm	22,10

Non utilizzare le barre di torsione per svitare i dadi, ma solo per avvitare.

Per sicurezza, si consiglia di controllare sempre il serraggio con chiave dinamometrica.

BARRE DI TORSIONE

1/2"

BARRE DI TORSIONE CON QUADRO MASCHIO

Kokon articolo	Nm	D mm	L mm	Euro
14112-P-90Nm	90	25	208	29,67
14112-P-95Nm	95	25	202	29,67
14112-P-100Nm	100	25	196	29,67
14112-P-110Nm	110	25	213	30,31
14112-P-120Nm	120	25	201	30,31
14112-P-130Nm	130	25	203	30,31
14112-P-140Nm	140	25	205	30,31
14112-P-150Nm	150	25	205	30,31
14112-P-170Nm	170	25	195	30,31

IMPACT AUTOMOTIVE 1/2"



BARRE DI TORSIONE



FAST LEAD

BARRE DI TORSIONE BOCCA FAST LEAD

Koken articolo	mm	Nm	D mm	L mm		Euro
14101M-14 X 95 NM	14	95	22	208	1	27,86
14101M-15 X 110 NM	15	110	23.2	201	1	27,86
14101M-17 X 60 NM	17	60	25.7	216	1	27,86
14101M-17 X 75 NM	17	75	25.7	228	1	27,86
14101M-17 X 95 NM	17	95	25.7	214	1	27,86
14101M-17 X 110 NM	17	110	25.7	204	1	27,86
14101M-17 X 120 NM	17	120	25.7	200	1	27,86
14101M-19 X 60 NM	19	60	28.2	219	1	28,63
14101M-19 X 90 NM	19	90	28.2	223	1	28,63
14101M-19 X 110 NM	19	110	28.2	214	1	28,63
14101M-19 X 120 NM	19	120	28.2	203	1	28,63
14101M-19 X 135 NM	19	135	28.2	206	1	28,63
14101M-19 X 170 NM	19	170	28.2	190	1	28,63
14101M-21 X 100 NM	21	100	30.7	214	1	31,24
14101M-21 X 120 NM	21	120	30.7	203	1	31,24
14101M-22 X 160 NM	22	160	32	209	1	35,59

BARRE DI TORSIONE

Koken



BARRE DI TORSIONE

COLORATE



FAST LEAD

Koken articolo	mm	Nm	Colore	L mm		Euro
14101MP-17 X 95 NM	17	95		214	1	37,79
14101MP-17 X 110 NM	17	110		204	1	37,79
14101MP-17 X 120 NM	17	120		200	1	37,79
14101MP-19 X 90 NM	19	90		259	1	38,56
14101MP-19 X 100 NM	19	100		233	1	38,56
14101MP-19 X 120 NM	19	120		203	1	38,56
14101MP-19 X 140 NM	19	140		199	1	38,56
14101MP-21 X 100 NM	21	100		214	1	41,17
14101MP-21 X 120 NM	21	120		203	1	41,17
14101MP-22 X 150 NM	22	150		220	1	51,15

14101MP/8

 ESPOSITORE 8 PEZZI:
 17x95 Nm, 17x110 Nm,
 17x120 Nm, 19x90 Nm,
 19x100 Nm, 19x120 Nm,
 19x140 Nm, 21x100 Nm

301,40

Non utilizzare le barre di torsione per svitare i dadi, ma solo per avvitarle.

Per sicurezza, si consiglia di controllare sempre il serraggio con chiave dinamometrica.

BARRE DI TORSIONE



1"

ESAGONO

BARRE DI TORSIONE BOCCA ESAGONALE

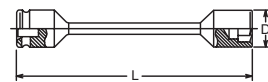

Koken articolo	mm	Nm	D mm	L mm		Euro
18101M-24 X 350 NM	24	350	43.5	300	1	114,65
18101M-27 X 350 NM	27	350	47	300	1	114,65
18101M-27 X 450 NM	27	450	47	300	1	114,65
18101M-29 X 400 NM	29	400	47.8	300	1	114,65
18101M-30 X 500 NM	30	500	51	300	1	118,83
18101M-32 X 450 NM	32	450	53.5	300	1	124,05
18101M-32 X 550 NM	32	550	53.5	300	1	124,05
18101M-32 X 600 NM	32	600	53.5	300	1	124,05
18101M-32 X 700 NM	32	700	53.5	300	1	124,05
18101M-33 X 550 NM	33	550	55	300	1	124,05
18101M-33 X 600 NM	33	600	55	300	1	124,05
18101M-33 X 650 NM (OZAT)	33	650	58.5	300	1	196,35
18101M-36 X 600 NM	36	600	58.5	300	1	139,40



BARRE DI TORSIONE



3/4"



BARRE DI TORSIONE BOCCA ESAGONALE

Koken articolo	mm	Nm	D mm	L mm		Euro
16101M-24 X 180 NM	24	180	38.8	235	1	106,81
16101M-27 X 450 NM	27	450	42.5	280	1	110,41
16101M-32 X 600 NM	32	600	48.8	280	1	115,47
16101M-33 X 600 NM	33	600	50	280	1	114,70

